

Instructions for Use

Oxylog 3000 *plus*



WARNING
To properly use this medical device,
read and comply with these
Instructions for Use.

**Emergency and Transport Ventilator
Software 1.n**

Typographical Conventions

- 1 Consecutive numbers indicate steps of action, with the numbering restarting with "1" for each new sequence of actions.
- Bullet points indicate individual actions or different options for action.
- Dashes indicate the listing of data, options, or objects.
- (A) Letters in parentheses refer to elements in the related illustration.
- A Letters in illustrations denote elements referred to in the text.

Any text shown on the screen and any labeling on the device are printed in bold and italics, for example, ***PEEP***, ***Air***, or ***Alarm settings***.

The "greater than" symbol > indicates the navigation path in a dialog window, for example, ***System setup > Monitoring > Basic settings***. In this example, ***System setup*** represents the dialog window title, ***Monitoring*** represents a horizontally aligned tab, and ***Basic settings*** a vertically aligned tab.

Screen images

Schematic renderings of screen images are used, which may differ in appearance or in configuration from the actual screen images.

Trademarks

- Oxylog[®]
- AutoFlow[®]
- DrägerService[®]

are trademarks owned by Dräger.

- Sekusept[®]

is a trademark of ECOLAB.

- BIPAP*

* Trademark used under license

Safety Information Definitions

WARNING

A **WARNING** statement provides important information about a potentially hazardous situation which, if not avoided, could result in death or serious injury.

CAUTION

A **CAUTION** statement provides important information about a potentially hazardous situation which, if not avoided, may result in minor or moderate injury to the user or patient or in damage to the equipment or other property.

NOTE

A **NOTE** provides additional information intended to avoid inconvenience during operation.

Definition of target groups

For this medical device, users, service personnel, and experts are defined as target groups.

These target groups must have been instructed in the use of the medical device and must have the necessary expertise, training, and knowledge to use, install, reprocess, maintain or repair the medical device.

Dräger emphasizes that the medical device must be used, installed, reprocessed, maintained or repaired exclusively by the defined target groups.

Users

Users are intended operators as defined on page 14 hereof for the use of the medical device in accordance with its intended use.

Service Personnel

Service Personnel are persons who are responsible for the maintenance of the medical device towards the operating organization.

Service Personnel are persons who are authorized to install, reprocess, or maintain the medical device.

Experts

Experts are persons who are authorized to carry out repair or complex maintenance work on the medical device.

Abbreviations and Symbols

Please refer to "Abbreviations" on page 23 and "Symbols" on page 24 for explanations.

Contents

For Your Safety and that of Your Patients	7	Preparation for use after system check, CO ₂ zero calibration and filter check	60
General Safety Information	8	Operation	61
Product-specific Safety Information	11	Starting operation	62
Application	13	Preparing ventilation mode	64
Intended use	14	VC-CMV, VC-AC	65
Indications / Contraindications	14	VC-SIMV, VC-SIMV/PS	68
Environment of use	15	PC-BIPAP, PC-BIPAP/PS	71
System Overview	17	SpnCPAP, SpnCPAP/PS	73
Front panel with all options	18	NIV – Non-invasive ventilation (Mask ventilation)	76
Range of functions	22	Special functions	77
Abbreviations	23	O ₂ concentration with "O ₂ blending"	79
Symbols	24	Setting HME correction	80
Operating Concept	27	Calibration	81
Switch on or off	28	Screen brightness	81
Ventilation controls	29	Alarm volume	81
Display operating controls	30	Shutdown	82
Additional function keys	31	Alarms	83
Screen window structure	32	Types of alarms	84
Assembly	35	In the event of an alarm	85
Internal rechargeable battery	37	Setting alarm limits	87
Connecting the power supply	38	Monitoring	89
External power supply	39	Displaying curves	90
Connecting the gas supply	41	Displaying measured values	90
Assembling the adult reusable hose system	43	CO ₂ measurement (optional)	91
Connecting the adult disposable hose system	45	Configuration	95
Connecting the paediatric disposable hose system	46	Setting configuration parameters / display information	96
Connecting the bacterial filter or HME	47	Displaying configuration and information	97
Connecting the CO ₂ sensor and the cuvette	48	Customer Service Mode	98
Hanging the Oxylog 3000 <i>plus</i> on standard rail systems	49	Customer service manual	110
Getting Started	51	Problem Solving	111
Charging the battery	52	Alarm - Cause - Remedy	112
Determining the approximate pneumatic operating time	53	Messages in the alarm window	112
Checking readiness for operation	54	Messages in the information window	120
CO ₂ zero calibration and filter check before ventilation (optional)	58	Error messages during the device check	122

Cleaning, Disinfection and Sterilization . . .	123
Disassembly	124
Safety Information on reprocessing	127
Reprocessing procedure	127
Reprocessing list	131
Assembling parts	131
Maintenance	133
Maintenance intervals of Oxylog 3000 <i>plus</i> . .	134
Safety inspections	135
Exchanging the internal battery	136
In case of ventilator failure	136
Disposal	137
Disposing of the medical device	138
Disposal instructions	138
Technical Data	139
Ambient conditions	140
Settings	141
Performance data	143
Measured values and curves display	144
Monitoring	145
Operating data	146
Device specifications	149
Materials used	150
Technical Documentation for the Oxylog 3000 <i>plus</i> according to EMC standard IEC 60601-1-2	152
Principles of Operation	157
Ventilation modes	158
AutoFlow	162
Dead space	164
Determining the cycle time, inspiratory time and expiratory time	164
Functional description	165
List of Accessories	167
Index	169

For Your Safety and that of Your Patients

General Safety Information	8
Strictly follow these Instructions for Use.	8
Maintenance.	8
Accessories	8
Connected Devices	9
Safe connection with other electrical equipment.	9
Modifications.	9
Patient safety	9
Patient monitoring.	9
Information on Electromagnetic Compatibility	9
Functional safety	10
Appropriate monitoring	10
Product-specific Safety Information	11
Installing accessories	11
Instructions for Use only available once.	11

General Safety Information

The following WARNINGS and CAUTIONS apply to general operation of the device. WARNINGS and CAUTIONS specific to subsystems or particular features appear with those topics in later sections of the manual.

Strictly follow these Instructions for Use

WARNING

Risk of incorrect operation and of incorrect use

Any use of the medical device requires full understanding and strict observation of all sections of these Instructions for Use. The medical device must only be used for the purpose specified under "Intended use" on page 14 and in conjunction with appropriate patient monitoring.

Strictly observe all WARNING and CAUTION statements throughout these Instructions for Use and all statements on medical device labels. Failure to observe these safety information statements constitutes a use of the medical device that is inconsistent with its intended use.

Maintenance

WARNING

Risk of medical device failure and of patient injury

The medical device must be inspected and serviced regularly by service personnel. Repair and complex maintenance work carried out on the medical device must be performed by experts.

Dräger recommends that a service contract is obtained with DrägerService and that all repairs are performed by DrägerService. For maintenance Dräger recommends the use of authentic Dräger repair parts.

If the above are not complied with, medical device failure and patient injury cannot be excluded.

Observe chapter "Maintenance".

Accessories

WARNING

Risk due to unreleased accessories

If unreleased accessories are used, there is a risk of patient injury due to medical device failure.

Only use the medical device together with released accessories listed in the current list of accessories.

Connected Devices

WARNING

Risk of electric shock and of device malfunction

Any connected devices or device combination, not complying with the requirements mentioned in these Instructions for Use can compromise the correct functioning of the medical device and lead to an electric shock. Before operating the medical device, strictly comply with the Instructions for Use of all connected devices or device combinations.

Safe connection with other electrical equipment

CAUTION

Risk of patient injury

Electrical connections to equipment not listed in these Instructions for Use or these Assembly Instructions must only be made when approved by each respective manufacturer.

Modifications

WARNING

Modification of the device is not allowed.

Patient safety

The design of the medical device, the accompanying literature, and the labeling on the medical device are based on the assumption that the use of the equipment is restricted to trained professionals, and that certain inherent characteristics of the medical device are known to the trained operator. Instructions, warnings, and caution statements are limited, therefore, largely to the specifics of the Dräger design.

This publication excludes references to various hazards which are obvious to a medical professional and operator of this medical device, to the consequences of medical device misuse, and to potentially adverse effects in patients with abnormal conditions.

Medical device modification or misuse can be dangerous.

Patient monitoring

The operators of the medical device are responsible for choosing appropriate safety monitoring that provides adequate information on medical device performance and patient condition.

Patient safety may be achieved through a wide variety of means, ranging from electronic surveillance of medical device performance and patient condition, to simple, direct observation of clinical signs.

The responsibility for the selection of the best level of patient monitoring lies solely with the medical device operator.

Information on Electromagnetic Compatibility

General information on electromagnetic compatibility (EMC) pursuant to international EMC standard IEC 60601-1-2:

Electromedical devices are subject to special precautionary measures concerning electromagnetic compatibility (EMC) and must be installed and put into operation in accordance with the EMC information. Refer to section "Technical Documentation for the Oxylog 3000 plus according to EMC standard IEC 60601-1-2" on page 152.

WARNING

Do not use portable and mobile HF communications equipment, e.g., mobile phones, in the vicinity of the medical device.

Functional safety

The essential performance of the Oxylog 3000 *plus* is defined as:

Appropriate delivery of ventilation to the patient-connection port or generation of an alarm condition.

Appropriate monitoring

CAUTION

Always use a separate SpO₂ monitor for patients who are dependent on an exact O₂ concentration.

The monitoring functionality of the Oxylog 3000 *plus* ensures appropriate monitoring of ventilation therapy. To ensure appropriate monitoring during ventilation, always set the following alarm limits:

- Airway pressure, P_{aw}
- Expiratory minute volume, M_{Ve}
- Respiratory rate (if applicable), RR
- etCO₂ (if applicable)

Not setting appropriate alarm limits could suppress alarms related to:

- Acute changes in the patient's condition
- Incorrect settings and faulty handling
- Hose system leakage

Product-specific Safety Information

WARNING

Ventilation monitoring is mandatory at all times! Whenever a patient is connected to the ventilator, constant attention by qualified medical staff is required in order to provide immediate corrective action in case of a malfunction.

The operator shall not solely rely on the built-in monitoring of the ventilator and must always assume full responsibility for proper ventilation and patient safety in all situations.

WARNING

Keep a manual breathing bag available.

If a failure is detected in the ventilator and its life-support functions can no longer be guaranteed (e.g. in case of a power supply failure or interruption in the O₂ supply), ventilation must be started without delay with an independent ventilator (breathing bag) – using PEEP and/or increased inspired O₂ concentration as necessary.

WARNING

To ensure proper ventilation, consider the total dead space of the breathing circuit, especially when using small tidal volumes. Observe for signs of rebreathing.

Risk of CO₂ rebreathing.

NOTE

An etCO₂ value by itself is insufficient as a basis for medical decisions.

Installing accessories

CAUTION

Installations on the Oxylog 3000 *plus* must be done in accordance with these Instructions for Use. Make sure that the connections are securely fitted onto the basic system.

Strictly follow the Assembly Instructions and Instructions for Use.

Instructions for Use only available once

NOTE

Only one copy of the Instructions for Use is included in the clinical package and should therefore be kept in an accessible location for users.

This page intentionally left blank

Application

Intended use	14
Indications / Contraindications	14
Environment of use	15

Intended use

The Oxylog 3000 *plus* is a time-cycled, volume-controlled and pressure-controlled emergency and transport ventilator for patients requiring mandatory or assisted ventilation with a tidal volume from 50 mL upwards.

Intended operator: the device is intended for use by and under the supervision of trained healthcare professionals, e.g. doctors, nurses, emergency medical technicians, respiratory therapists, and paramedics.

Indications / Contraindications

The device is intended for use with patients with a tidal volume of 50 mL upwards.

WARNING

The Oxylog 3000 *plus* ventilator may only be used under the supervision of trained healthcare professionals in case immediate corrective action is required in the event of a device failure.

Environment of use

Intended environment of use:

- Mobile use for emergency patients, in both outdoor and indoor environments.
- During transport in ambulances or aircraft, including helicopters.
- In accident and emergency departments.
- When moving ventilated patients around the hospital.
- In the recovery room.

WARNING

Do not use the medical device in hyperbaric chambers.

The medical device may malfunction, causing danger to the patient.

WARNING

Do not use the medical device in conjunction with magnetic resonance imaging (MRI, NMR, NMI).

The medical device may malfunction, causing danger to the patient.

WARNING

This medical device is neither approved nor certified for use in areas where combustible or explosive gas mixtures are likely to occur.

This page intentionally left blank

System Overview

Front panel with all options	18
Side view, right	19
Rear view	19
Adult hose system, reusable	20
Adult hose system, disposable	20
Paediatric hose system, disposable	21
Range of functions	22
Ventilation functions of the Oxylog 3000 plus.	22
Abbreviations	23
Symbols	24

Front panel with all options

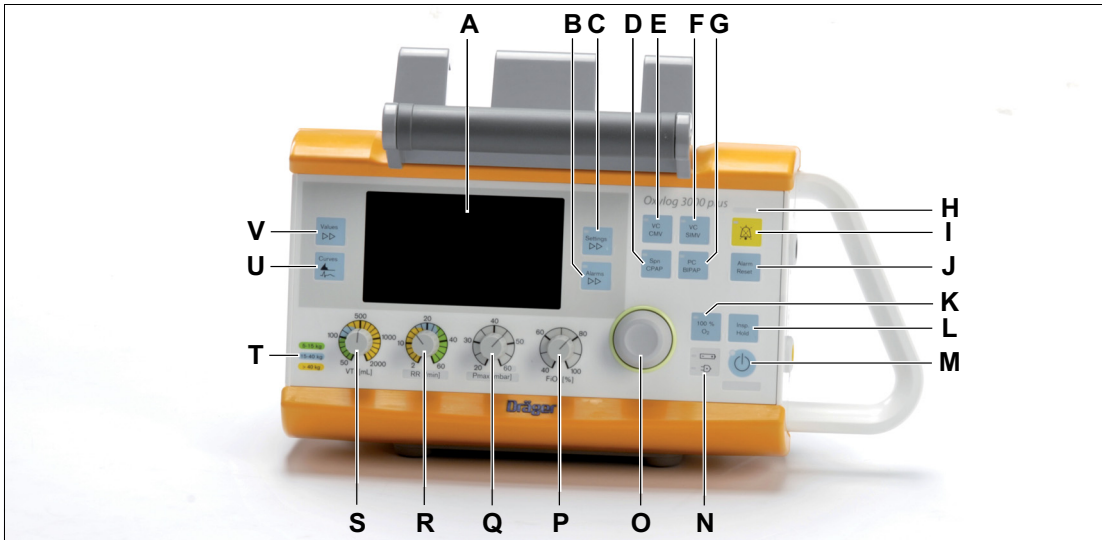

Front

- A** Screen with screen pages for the specific application
- B** Key **Alarms** to display the alarm settings in the "Settings and Alarms" window and to change screen pages
- C** Key **Settings** to display ventilation parameters (ventilation screen) in the "Settings and Alarms" window and to change screen pages
- D** Key for setting the ventilation mode **SpnCPAP**
- E** Key for setting the ventilation modes **VC-CMV / VC-AC**
- F** Key for setting the ventilation mode **VC-SIMV**
- G** Key for setting the ventilation mode **PC-BIPAP**
- H** Red and yellow alarm indicators
- I** Key for suppressing the acoustic alarm signal for 2 minutes
- J** Key **Alarm Reset** for acknowledging alarm messages
- K** Key **O₂ inhalation** for O₂ inhalation or key **100 % O₂** for 100 % O₂ application, depending on the option installed at manufacture
- L** Key **Insp. Hold** for initiating a manual inspiration or for extending the current inspiratory time.
- M** Key Start/Standby
- N** Display symbols for the power supply
 - Charge status of the internal battery
 - Mains power supply connected
- O** Rotary knob for making selections, changing and confirming settings
- P** Control knob for setting the O₂ concentration **FiO₂**
- Q** Control knob for setting the maximum inspiratory pressure **P_{max}**
- R** Control knob for setting the respiratory rate **RR**
- S** Control knob for setting the tidal volume **VT**
- T** Explanation of color codes for quick pre-setting of **RR** and **VT**
- U** Key **Curves** to change between the pressure, flow or CO₂ (optional) curve in small and large presentation
- V** Key **Values** to change screen pages in the "Measured Values" window

Side view, right

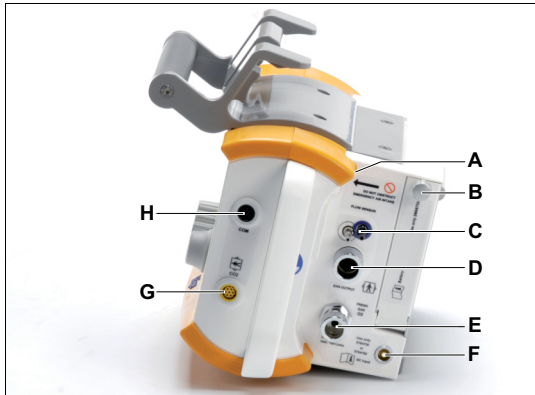

A Emergency air intake

CAUTION

Do not block the emergency air intake. This may result in ventilator malfunction.

B Knob to secure the battery compartment cover

C Connectors for flow measuring lines

D Gas outlet for breathing hose

E Connector for O₂ supply

F Connector for power supply

G Connector for CO₂ sensor

H Connector for data communication cable

Rear view

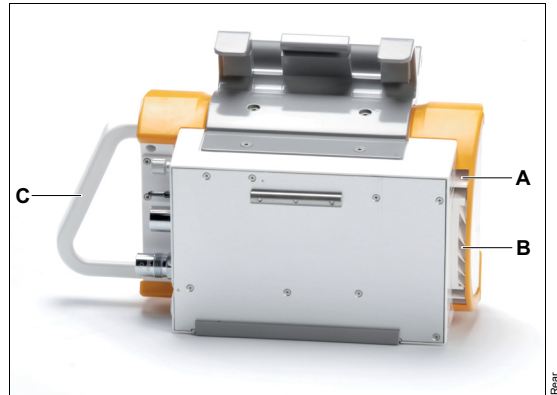

A Emergency air intake

CAUTION

Do not block the air intake. This may result in ventilator malfunction.

B Fresh-gas intake with a filter cartridge

C Protection bracket

CAUTION

Do not use the protection bracket as a handle. Tilting the device to a vertical position may lead to airway pressure oscillation.

Adult hose system, reusable

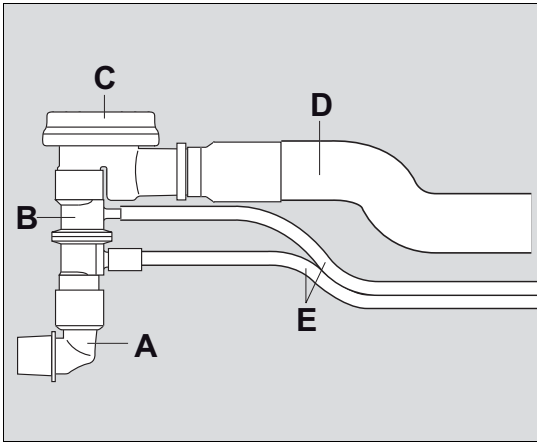

- A** Angled connector
- B** Flow sensor
- C** Breathing valve
- D** Breathing hose
- E** Flow and pressure measuring hoses

Adult hose system, disposable

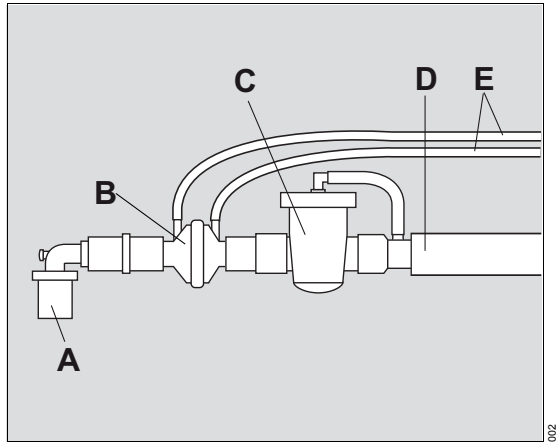

- A** Angled connector
- B** Flow sensor
- C** Breathing valve
- D** Breathing hose
- E** Flow and pressure measuring hoses

Paediatric hose system, disposable

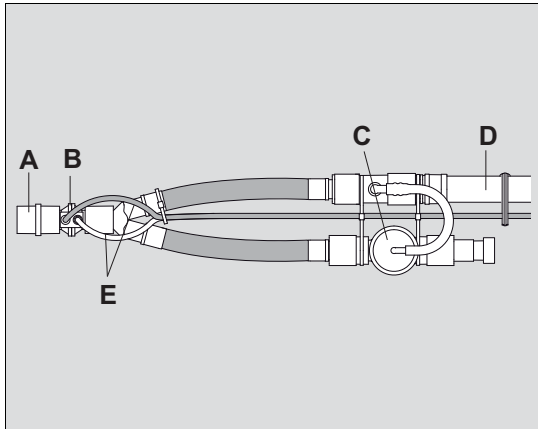

- A** Angled connector
- B** Flow sensor
- C** Breathing valve
- D** Breathing hose
- E** Flow and pressure measuring hoses

Range of functions

Ventilation functions of the Oxylog 3000 *plus*

Ventilation modes:

- Volume-controlled ventilation:
 - VC-CMV / VC-AC,
 - VC-SIMV.
- Pressure-controlled ventilation:
 - PC-BIPAP.
- Support of spontaneous breathing:
 - SpnCPAP.

Additional settings for ventilation:

- Pressure Support: in the ventilation modes VC-SIMV, PC-BIPAP, SpnCPAP,
- Apnoea ventilation: in the ventilation mode SpnCPAP,
- AutoFlow (optional): in the ventilation modes VC-CMV, VC-AC and VC-SIMV.
- NIV: in the ventilation modes: SpnCPAP (/PS), PC-BIPAP (/PS), VC-CMV / AF, VC-AC / AF and VC-SIMV / AF.

Special procedures:

- Inspiration hold,
- O₂ inhalation (optional), with an inhalation mask.

For a detailed description of the ventilation modes and the additional settings, refer to "Principles of Operation" on page 157. For abbreviations, see "Abbreviations" on page 23.

NOTE

In these Instructions for Use the unit of measurement for airway pressure is expressed in [mbar]. However, in some languages the display of the Oxylog 3000 *plus* shows [cmH₂O].

One [mbar] equals approximately one [cmH₂O].

Abbreviations























Abbreviation Explanation

100 % O ₂	100 % O ₂ flow
AF	AutoFlow
BF	Body Floating
bpm	Breaths per minute
BTPS	Body Temperature, Pressure Saturated
C	Lung compliance
CO ₂	Carbon dioxide
CSM	Customer Service Mode
ΔP _{supp}	Positive pressure above PEEP
EMC	Electromagnetic Compatibility
ESD	Electrostatic Discharge
etCO ₂	Endtidal CO ₂ concentration
FiO ₂	Fractional inspired oxygen concentration
FRC	Functional Residual Capacity
HME	Heat and Moisture Exchange
I:E	Ratio inspiratory time to expiratory time
IPX2	Ingress Protection level 2
IPX4	Ingress Protection level 4
MVe	Expiratory minute volume
MVi	Inspiratory minute volume
MV _{espon}	Spontaneous expiratory minute volume
NIV	Non-invasive ventilation – mask ventilation
O ₂	Oxygen
O ₂ -Inhalat.	O ₂ inhalation
Paw	Airway pressure
PC-BIPAP	Pressure Controlled - Biphasic Positive Airway Pressure
PEEP	Positive End Expiratory Pressure



Abbreviation Explanation

PIF	Peak Inspiratory Flow
P _{insp}	Inspiratory pressure
PIP	Peak Inspiratory Pressure
P _{max}	Maximum allowed inspiratory pressure
P _{mean}	Mean airway pressure
P _{plat}	Plateau pressure
PS	Pressure Support
R	Resistance
RF	Radio Frequency
RR	Respiratory Rate (frequency)
RR _{apn}	Respiratory Rate during apnoea ventilation
RR _{sp}	Spontaneous Respiratory Rate
SpnCPAP	Spontaneous Continuous Positive Airway Pressure
SpO ₂	Saturation of peripheral oxygen
T _{apn}	Time before apnoea is recognized
T _e	Expiratory time
T _i	Inspiratory time
T _{plat} %	Plateau time in % of inspiratory time
UN	United Nations
VC-AC	Volume Controlled - Assist Control
VC-CMV	Volume Controlled - Controlled Mandatory Ventilation
VC-SIMV	Volume Controlled - Synchronized Intermittent Mandatory Ventilation
VT	Tidal volume
VT _{apn}	Tidal volume during apnoea ventilation
VTe	Expiratory tidal volume
VTi	Inspiratory tidal volume

Symbols

Symbol	Explanation	Symbol	Explanation
	Key for initiating a manual inspiration or for extending the current inspiratory time.	*	Trigger indicator
	Key to display ventilation parameters (ventilation screen) in the "Settings and Alarms" window and to change screen pages.		Warning
	Key to display the alarm settings in the "Settings and Alarms" window and to change screen pages.		Defibrillation-proof type BF applied part
	Key to change screen pages in the "Measured Values" window.		Charge status of the internal battery
	Key to change between the pressure, flow or CO ₂ (optional) curve in small and large presentation.		External power supply connected
	Key for suppressing the acoustic alarm signal for 2 minutes.		Battery charge (example: three quarters full)
	Key for acknowledging alarm messages.		Class II equipment, device protected against electric shock with additional safety precautions such as double or reinforced insulations, without protective earthing.
	Rotary knob		Do not dispose of the device as municipal waste.
	Start / Standby key		Manufacturing date
	Upper alarm limit		Manufacturer
	Lower alarm limit		DC input
!	Advisory message		Operating instructions
!!	Caution message		Follow Instructions for Use
!!!	Warning message		

Symbol	Explanation
	For dry locations only
	Caution, hot surface!
	Warning, dangerous voltage!
	Temperature limitations
	Latex free
	Do not reuse
	Do not use oil and grease
	Non-sterile
	Keep away from sunlight
	For indoor use only
	Do not open
	Prohibition: Do not obstruct emergency air intake or fresh gas intake
	Paediatric
	Adult

Symbol	Explanation
	Slope (steep, medium, flat)
	Quantity

This page intentionally left blank

Operating Concept

Switch on or off	28
Switch on	28
Switch off	28
Ventilation controls	29
Display operating controls	30
Additional function keys	31
Screen window structure	32

Switch on or off

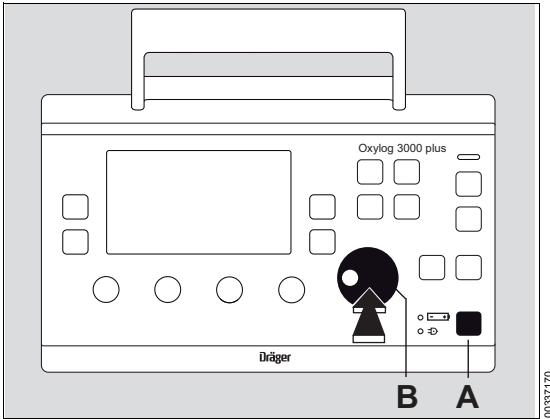

Switch on

- To switch the device ON, briefly press the  key (A).

Switch off

Refer to "Shutdown" on page 82.

Ventilation controls

General ventilation controls

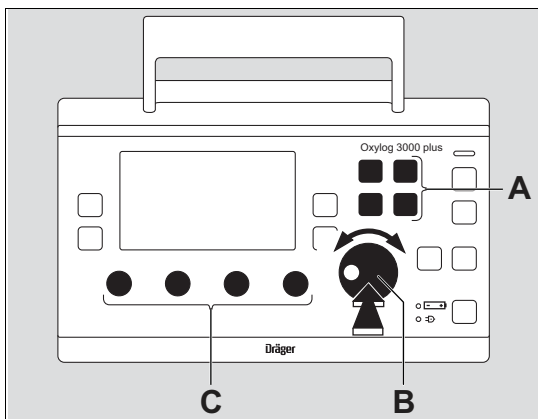

A Keys for selecting the ventilation modes:

- VC-CMV / VC-AC
- VC-SIMV
- SpnCPAP
- PC-BIPAP.

B Rotary knob.

C Ventilation parameter controls:

- Inspiratory tidal volume ***VT*** [mL],
- Ventilation respiratory rate ***RR*** [/min],
- Maximum inspiratory pressure ***Pmax*** [mbar],
- O₂ concentration ***FiO₂*** [%].

Selecting the ventilation mode

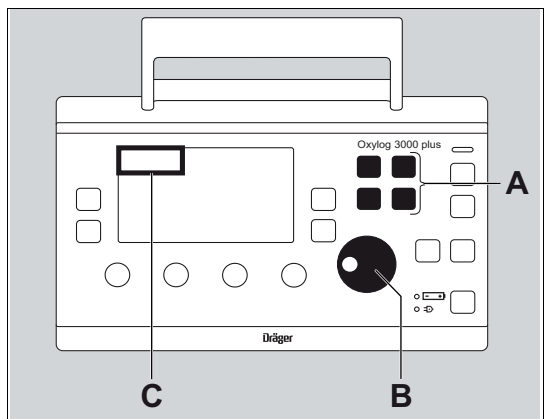

- Press the appropriate ventilation mode key (A) for approximately 3 seconds.

Or

- 1 Press the appropriate ventilation mode key (A).
- 2 Press the rotary knob (B) to confirm.

The selected ventilation mode will be activated.

The active ventilation mode is displayed in the upper left corner of the display (C).

Display operating controls

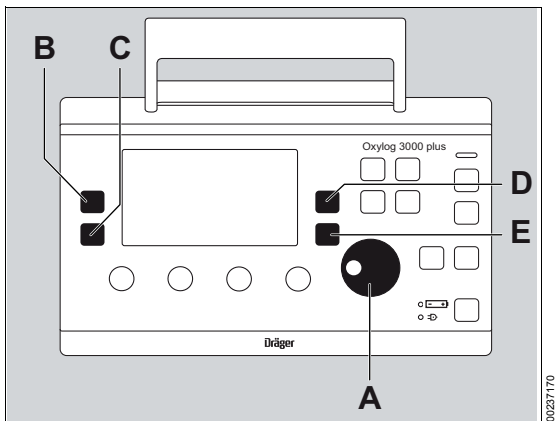



- A** Rotary knob for making selections, changing and confirming settings.

NOTE

Different parameters can be set in the display window via the rotary knob (e.g. T_i , PEEP, ΔP_{supp} , P_{insp}).

- To select the parameter: turn rotary knob.
- To activate the parameter: press rotary knob.
- To set the value: turn rotary knob.
- To confirm the value: press rotary knob.

- B** Key **Values**  to change screen pages in the "Measured Values" window.

- C** Key **Curves**  to change between the pressure, flow or CO₂ (optional) curve in small and large presentation.

- D** Key **Settings**  to display ventilation parameters (ventilation screen) in the "Settings and Alarms" window and to change screen pages.

- E** Key **Alarms**  to display the alarm settings in the "Settings and Alarms" window and to change screen pages.

Additional function keys

Additional keys are positioned on the right side of the front panel:

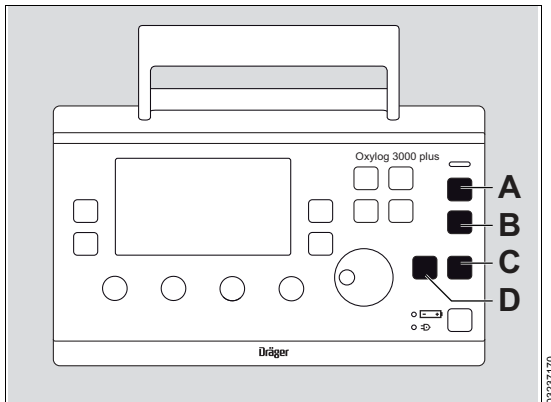

- A  key for suppressing the acoustic alarm signal for 2 minutes.
- B Key **Alarm Reset** for acknowledging alarm messages.
- C Key **Insp. Hold** for initiating a manual inspiration or for extending the current inspiratory time.
- D Key **O₂ inhalation** for O₂ inhalation or key **100 % O₂** for 100 % O₂ application, depending on the option installed at manufacture.

Screen window structure

General window structure

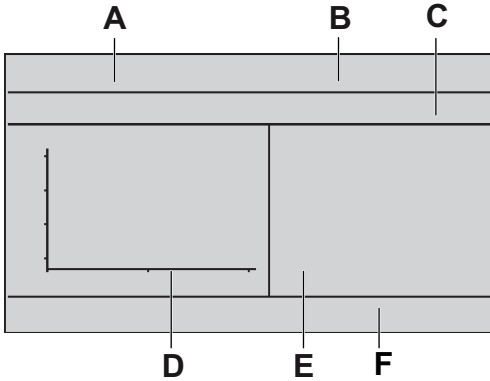

- A** Ventilation mode.
- B** Alarm messages field.
- C** Measured values window.
- D** Curve window.
D and E are combined for a large curve screen.
- E** Setting and alarm window.
- F** Information window. For information on the content, refer to "Messages in the information window" on page 120.

Measured values window

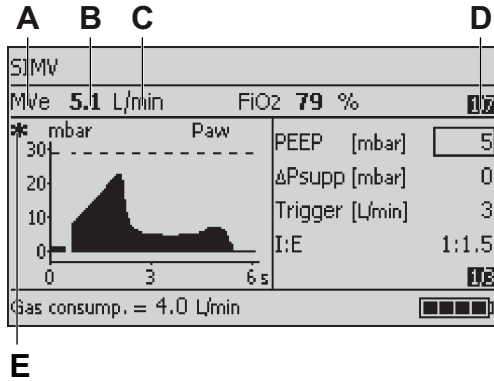

- A** Parameter measured.
- B** Measured value.
- C** Unit of measure.
- D** Measured values 1/7: 1st page of 7 available pages.
If CO₂ option is not installed: 1/6 available pages.
- E** Trigger indicator.

The last page shows an overview of all measured values.

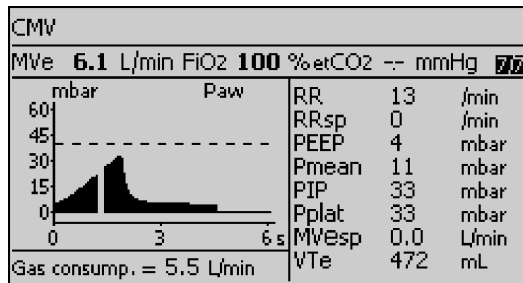

Settings window

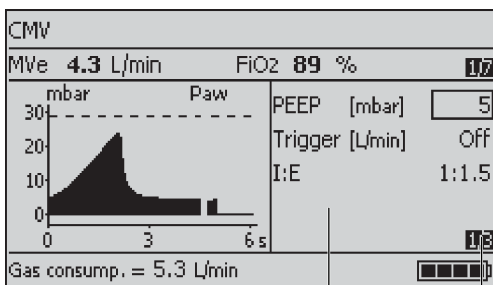

A B

A Menu for setting supplementary ventilation parameters in accordance with the desired ventilation mode.

- AutoFlow (optional)
- Brightness
- CO₂ filter check (optional)
- CO₂ zero calibration (optional)
- Cuvette type (optional)
- HME correction
- Hose type
- I:E / Ti
- NIV
- PEEP
- P_{insp}
- RR_{apn} and V_{Tapn}
- Slope
- Tapn
- T_{plat}
- Trigger
- ΔP_{supp}

B Page number: e.g. 1st page of 3 available pages.

- Press **Settings** $\triangleright\triangleright$ key.
The pages are displayed consecutively.

Alarms window

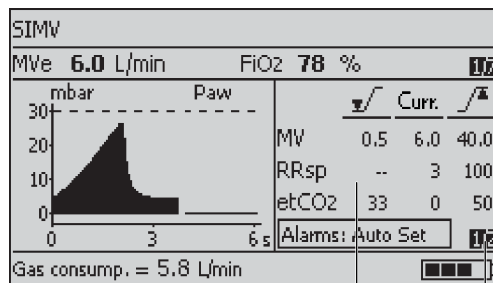

A B

A Menu for alarm limits and alarm parameters. For detailed operating instructions, see "Setting alarm limits" on page 87.

B Page number: e.g. 1st page of 2 available pages.

To advance to the next page:

- Press the **Alarms** $\triangleright\triangleright$ key.
The pages are displayed consecutively.

Pressure curve large view

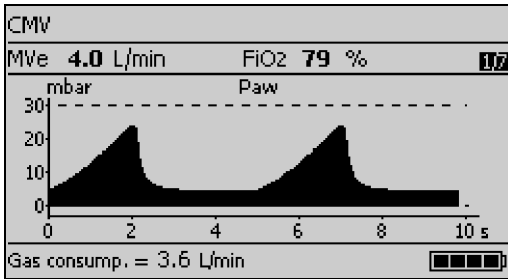

06637171

Curve window showing the airway pressure curve Paw.

- Press **Curves**  key multiple times.

Flow curve large view

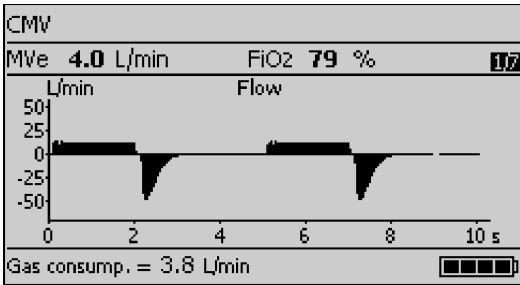

06637171

Curve window showing the flow curve.

CO2 curve large view

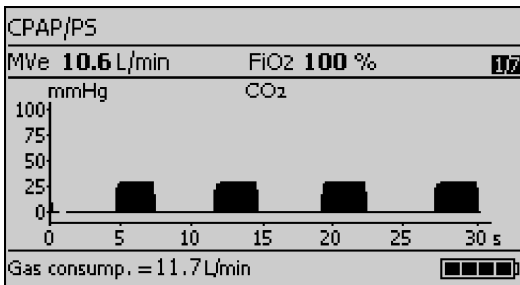

15437171

Curve window showing the CO2 curve.

Assembly

Internal rechargeable battery	37
Removing the battery	37
Checking the charge status of the battery . . .	37
Installing the battery	37
Connecting the power supply	38
External power supply	38
External power supply	39
External power supply with DC/DC converter	39
External power supply from mains voltage (AC/DC power pack).	40
Connecting the gas supply	41
Supply from an O ₂ cylinder	41
Supply from a piped O ₂ system	42
Assembling the adult reusable hose system	43
Breathing valve assembly.	43
Hose connections.	44
Connecting the adult disposable hose system	45
Connecting the paediatric disposable hose system	46
Connecting the bacterial filter or HME	47
Connecting the CO₂ sensor and the cuvette	48
Hanging the Oxylog 3000 plus on standard rail systems	49

WARNING

Avoid tripping on, or ensnaring, the breathing hose, CO₂ sensor cable, AC/DC supply cables, DC/DC supply cables or compressed gas hose.

There is a risk of injury and a risk of accidental extubation of the patient.

WARNING

Do not kink the patient breathing hoses while ventilating.

Risk of asphyxiation or hypoventilation.

WARNING

Do not use any damaged parts or accessories.

Damaged or deformed parts must be replaced.

WARNING

Data communication between the Oxylog 3000 *plus* and other equipment is only supported when using the MEDIBUS protocol.

WARNING

Electrical connections to equipment, which are not listed in these Instructions for Use, should only be made following consultation with the respective manufacturers.

Equipment malfunction may result as well as risk of patient injury.

WARNING

All equipment connected to the Oxylog 3000 *plus* must comply with IEC 60601-1-2.

WARNING

Do not combine parts of different hose systems, especially for paediatric applications.

Risk of CO₂ rebreathing.

WARNING

Always use the angled connector of the hose system.

If an angled connector is not used, the minute volume may be measured incorrectly.

WARNING

Do not use an adult breathing hose for tidal volumes below 100 mL.

Risk of CO₂ rebreathing.

CAUTION

Do not use the Oxylog 3000 *plus* without a dust filter.

Risk of patient inhaling dust or device damage.

CAUTION

Do not use electrically conductive hoses.

This can endanger the operator and damage the device during defibrillation.

Risk of electric shock.

Internal rechargeable battery

Internal power is provided by means of a removable rechargeable battery. For technical information, refer to "Technical Data" on page 139.

Removing the battery

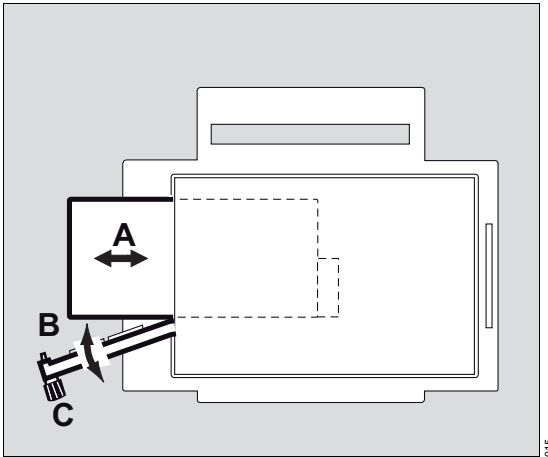

- 1 Turn the knob (C) on the battery compartment cover (B) counterclockwise to release the cover.
- 2 Open the battery cover.
- 3 Remove the battery (A) by pulling the tab.

Checking the charge status of the battery

- Press the button on the rechargeable battery. The charge status is indicated as a percentage by an indicator.

Installing the battery

- 1 Insert the battery into the battery compartment.
- 2 Close the battery cover.
- 3 Tighten the knob by turning it.

CAUTION

The Oxylog 3000 *plus* will interrupt ventilation when the battery is replaced while the device is switched on and the external power supply is not connected. Ventilation will always resume with the last values settings approximately 3 seconds after inserting a recharged battery.

Connecting the power supply

External power supply

To recharge the battery and to extend the electrical operation time, use either:

- DC/DC converter, or
- AC/DC power pack.

For more information refer to page 146.

WARNING

A fully charged battery must always be installed for safety reasons, even when operating from an external power supply.

CAUTION

Without a charged battery installed, ventilation will be interrupted in case of an external power failure.

NOTE

It is recommended to have a fully charged spare battery available when using the Oxylog 3000 *plus*.

Always position the device so that the external power connector can be easily disconnected from the ventilator.

External power supply

External power supply with DC/DC converter

WARNING

The DC/DC converter should be used in dry locations only.

Risk of electric shock or equipment damage.

The DC/DC converter must be used to connect the Oxylog 3000 *plus* to onboard DC power supply systems, e.g. in ambulances. It can be used with the following voltages: 12 VDC, 24 VDC or 28 VDC. The onboard power supply shall have a fuse of 10 to 16 A, suitable for DC current. Outside this range the Oxylog 3000 *plus* cannot use the DC input power.

Mount the DC/DC converter on a flat wall and make sure the wall is solid enough to support the bracket. Use all four mounting holes (screw size M4).

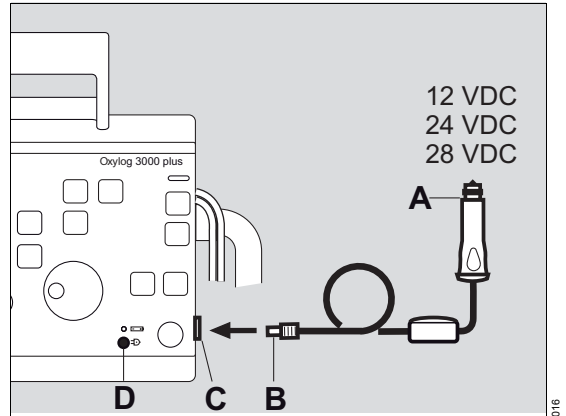

- 1 Plug the large connector (A) of the DC/DC converter into the on-board supply.
- 2 Plug the small connector (B) into the DC connector (C) of the Oxylog 3000 *plus*.
- 3 When the Oxylog 3000 *plus* is correctly connected to an external power supply, the indicator  (D) lights up.

External power supply from mains voltage (AC/DC power pack)

WARNING

The AC/DC power pack must not be used outdoors.

Risk of electric shock or equipment damage.

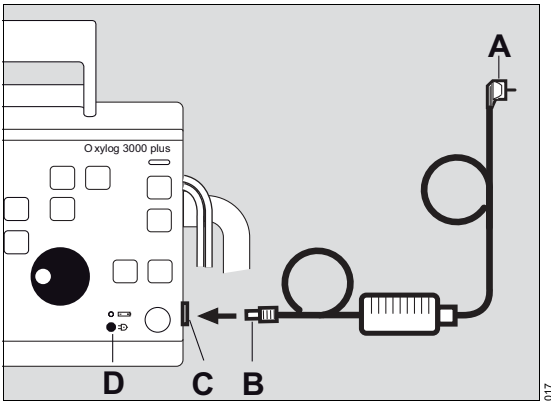

- 1 Connect the mains plug (A) to the mains outlet.
- 2 Connect the DC connector (B) to the DC connector (C) of the Oxylog 3000 *plus*.
- 3 When the Oxylog 3000 *plus* is correctly connected to an external supply, the indicator  (D) lights up.

To isolate the ventilator system from mains, disconnect the power cable from the wall connector.

Connecting the gas supply

Take care when handling O₂:

WARNING

Secure O₂ cylinders so they cannot fall over.
Keep away from excessive heat.

Risk of explosion.

WARNING

Do not grease or lubricate O₂ fittings, such as cylinder valves and pressure reducers and do not handle with greasy hands.

Risk of fire.

WARNING

Operate cylinder valves by hand and rotate slowly to prevent the risk of fire or explosion.

Do not use tools.

WARNING

Only use medical grade oxygen.

WARNING

Always provide adequate ventilation in the area where the ventilator is being operated, in order to maintain ambient O₂ concentration below 25 %, to prevent risk of fire.

WARNING

No smoking or open flames.

O₂ enhances combustion of other substances and can intensify fires.

Supply from an O₂ cylinder

WARNING

Always use gas cylinders and pressure regulators that comply with all applicable regulations.

CAUTION

Always use a full O₂ cylinder.

Risk of asphyxiation.

- 1 Connect the pressure reducer (270 to 600 kPa delivery pressure, 500 kPa nominal pressure) to the O₂ cylinder.

WARNING

Only use a pressure reducer with a relief valve at the outlet to limit the delivery pressure to a maximum of 1000 kPa in case of a malfunction, to prevent damage to the ventilator through excessive O₂ supply pressure on the input.

Supply from a piped O₂ system

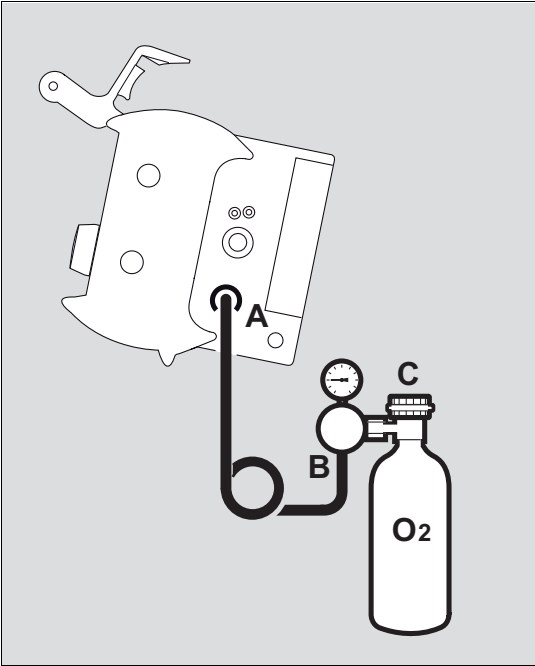

- 2 Connect the O₂ hose (A) to the Oxylog 3000 *plus*.
- 3 Connect the O₂ hose to the pressure reducer (B).
- 4 Rotate the cylinder valve (C) slowly and open fully.

WARNING

Do not connect flow control valves or flowmeters in the gas supply to the Oxylog 3000 *plus*.

The ventilator could malfunction.

WARNING

Always check the O₂ pressure of cylinder before use, to prevent insufficient oxygen supply during use.

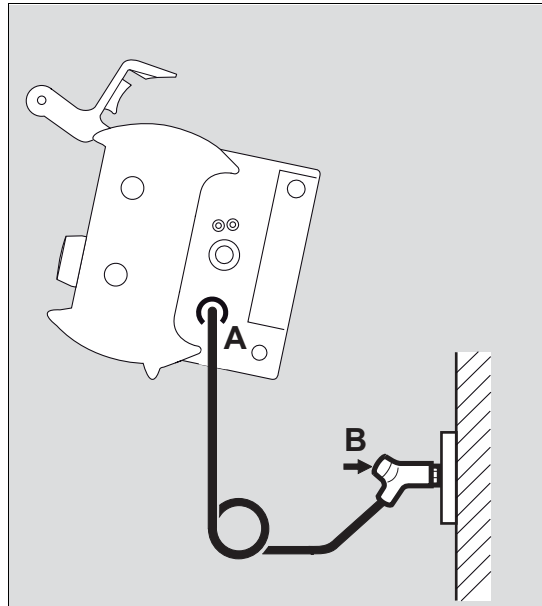

- 1 Connect the O₂ hose (A) to the Oxylog 3000 *plus*.
- 2 Connect the gas probe (B) to the O₂ terminal unit until it has properly engaged and the supply of O₂ is assured.

Assembling the adult reusable hose system

Reusable parts must always be sterilized before use!

Breathing valve assembly

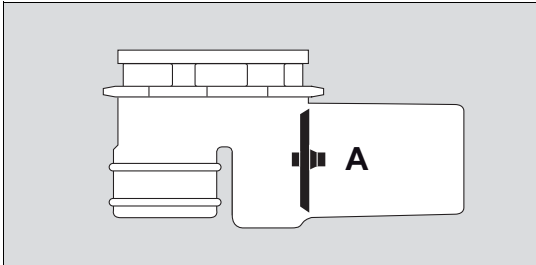

WARNING

The rubber disc (A) in the housing must not be removed, damaged or bent, otherwise the valve will not work properly and will endanger the patient.

Risk of CO₂ rebreathing.

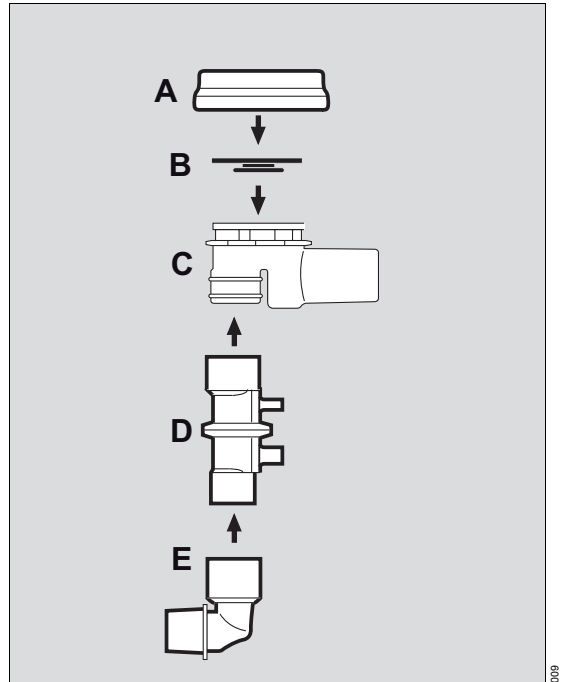

- 1 Place the diaphragm (B) in the breathing valve housing (C). Ensure that it is inserted correctly.
- 2 Fit the cover (A) and turn it approximately 60° clockwise to secure into position (a click can be felt).
- 3 Push the flow sensor (D) onto the breathing valve (C). Note the correct alignment of the parts by the groove in the flow sensor (D) and the notch on the breathing valve (C).
- 4 Push the angled connector (E) onto the flow sensor (D).

Hose connections

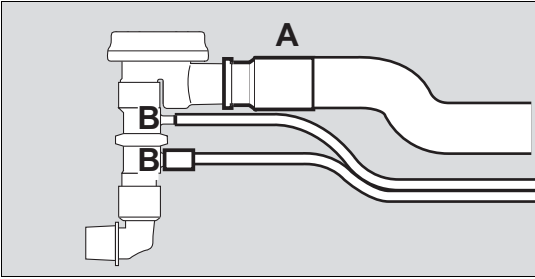

011

- 1 Connect the breathing hose (A) to the breathing valve.
- 2 Connect the flow measuring lines (B) to the nozzles on the flow sensor. Note the different diameters of the hoses and the nozzles when connecting the flow measuring lines and connect to the correct side.

- 3 Connect the flow measuring lines (A) to the Oxylog 3000 *plus*. Correct alignment is indicated by a notch on the connector, which must point away from the breathing hose. Otherwise, the set will not fit and the measured values will be incorrect.
- 4 Connect the breathing hose (B) to the gas outlet on the Oxylog 3000 *plus*.

When connecting a hose, check that the hose setting in the **Settings** window corresponds to the connected hose.

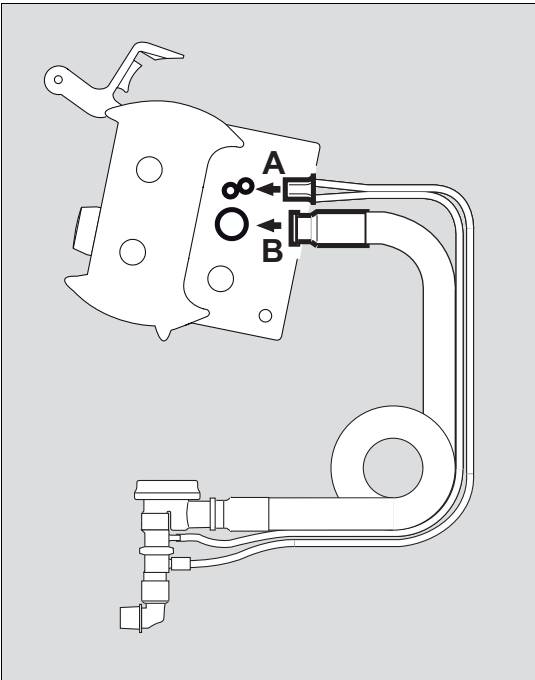

012

Connecting the adult disposable hose system

NOTE

Using a disposable hose may reduce the risk of cross-infection.

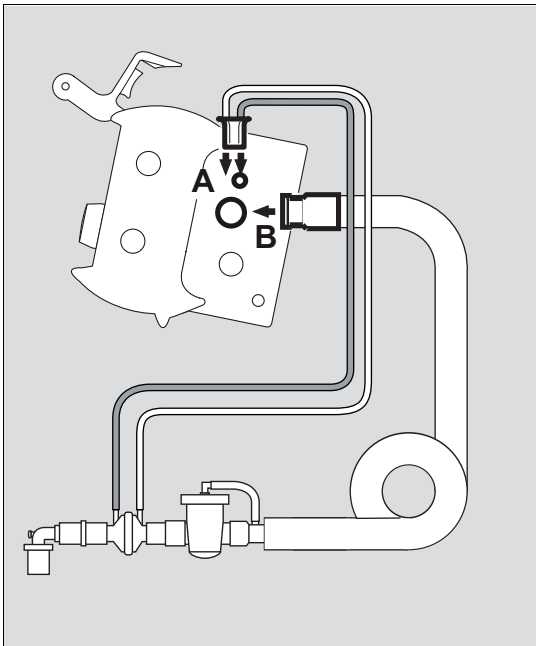

- 1 Connect the flow measuring lines (A) to the Oxylog 3000 *plus*. Correct alignment is indicated by a notch on the connector, which must point away from the breathing hose. Otherwise, the set will not fit and the measured values will be incorrect.
- 2 Connect the breathing hose (B) to the gas outlet on the Oxylog 3000 *plus*.

When connecting a hose, check that the hose setting in the **Settings** window corresponds to the connected hose.

Connecting the paediatric disposable hose system

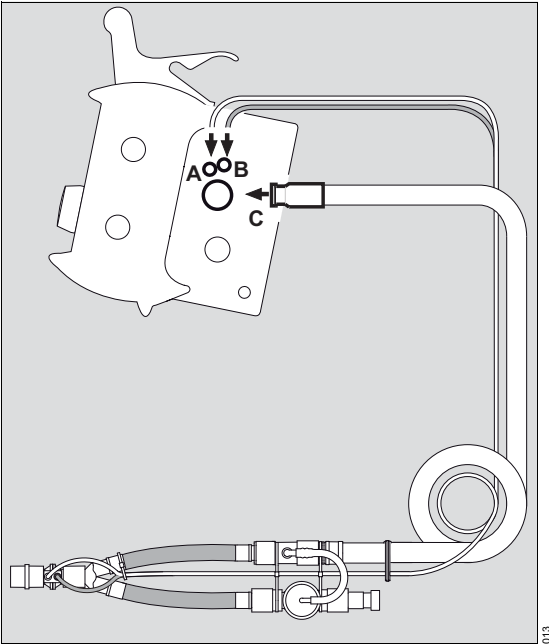

- 1 Connect the blue flow measuring line (B) to the blue labeled connector.
- 2 Connect the transparent flow measuring line (A) to the other connector.
- 3 Connect the breathing hose (C) to the gas outlet on the *Oxylog 3000 plus*.

When connecting a hose, check that the hose setting in the **Settings** window corresponds to the connected hose.

Connecting the bacterial filter or HME

WARNING

Bacterial filters, HME, and masks increase the resistance and dead space volume of the ventilation equipment. Note the manufacturer's directions.

Risk of CO₂ rebreathing.

NOTE

When using an HME, the measured flow may deviate from the actual expiratory flow, as temperature and humidity of the gas are reduced.

The flow and volume measurements can be corrected for use with an HME. Refer to "Setting HME correction" on page 80.

It is recommended to use a bacterial filter between ventilator and patient, to reduce the risk of bacteria, viruses, fungi or spores being present in the inspiratory flow.

- Connect the bacterial filter or HME to the angled connector as follows.

Adult reusable hose:

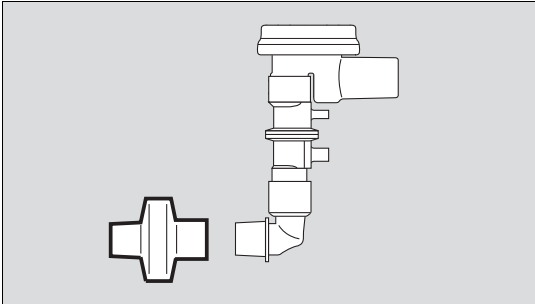

Adult disposable hose:

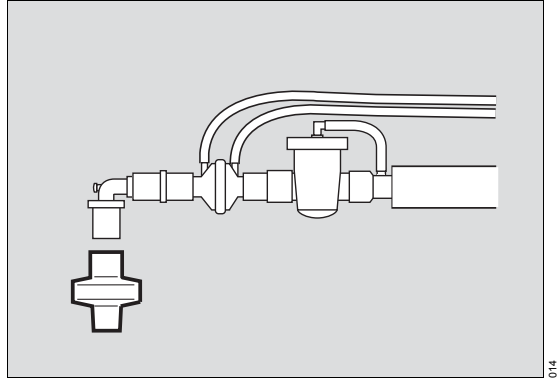

Paediatric hose:

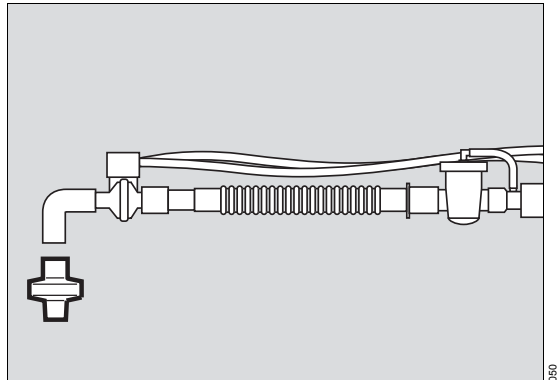

Connecting the CO₂ sensor and the cuvette

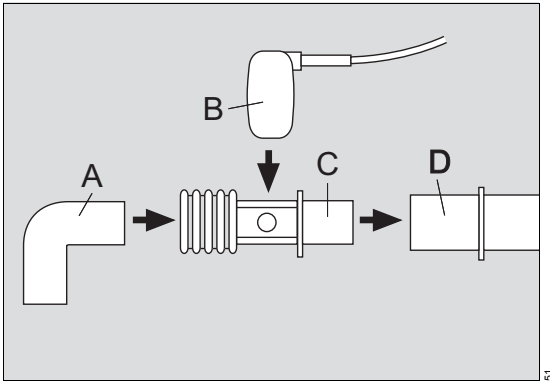

- 1 Disconnect the angled connector (A) from the flow sensor (D).
- 2 Attach the cuvette (C) to the flow sensor (D), with the cuvette windows facing the side.
- 3 Attach the angled connector (A) to the cuvette (C).
- 4 Push the CO₂ sensor (B) onto the cuvette (C), with the cable towards the device.
- 5 Plug the CO₂ sensor into the connector of the Oxylog 3000 *plus*. For the connector location, refer to the section "Side view, right" on page 19.
- 6 Insert the CO₂ sensor cable in the cable clips on the hose.

Alternatively, connect the cuvette (C) directly to the patient side of the angled connector (A), without disconnecting the angled connector from the flow sensor (D).

The CO₂ sensor cable can be extended with a maximum of one extension cable. Refer to "List of Accessories" on page 167.

For CO₂ zero calibration and filter check before ventilation, see page 58. For CO₂ zero calibration and filter check during ventilation, see page 91. For CO₂ measurement and cuvette type selection see page 91. For CO₂ configuration in the Customer Service Mode see page 105.

Hanging the Oxylog 3000 *plus* on standard rail systems

The Oxylog 3000 *plus* can be hung on various rail systems measuring up to 35 mm diameter by means of the claw.

- Ensure that the rail is completely inserted in the claw.
- To ensure optimal functioning of the claw, a distance of at least 25 mm between rail and wall is required.

WARNING

Be careful when placing the ventilator on the rail or bed rim.

Risk of damage to property or personal injury.

CAUTION

The Oxylog 3000 *plus* is only held by its own weight when hung on a bar or rail. The Oxylog 3000 *plus* must be secured additionally when being transported, otherwise vibrations may cause accidental dislodgement.

This page intentionally left blank

Getting Started

Charging the battery	52
Indication of battery capacity / battery operation.....	52
Determining the approximate pneumatic operating time	53
Checking readiness for operation	54
Perform device check.....	54
CO₂ zero calibration and filter check before ventilation (optional)	58
Zero calibration before ventilation	58
CO ₂ filter check before ventilation	59
Preparation for use after system check, CO₂ zero calibration and filter check	60

Charging the battery



The actual screen display may differ in appearance or configuration.

NOTE

The ambient temperature must be between 0 and 35 °C when charging the batteries.

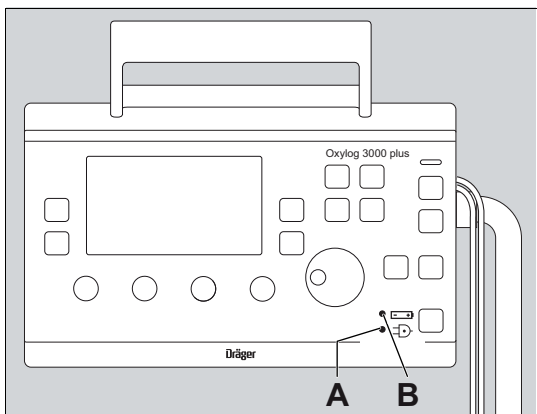
When an external supply is available:



- 1 The green indicator  (A) lights up when an external power source is connected.
 - 2 A three colored indicator  (B) lights up to show the current charge status of the internal battery:
 - Green: the battery is fully charged.
 - Yellow: the battery is being charged.
 - Red: a battery is not inserted or cannot be charged.
- Indicators (A) and (B) remain off while the ventilator is being operated from the internal battery.

An external battery charging station connected to the mains power supply can be used to charge an extra battery. Refer to the "List of Accessories" on page 167 for additional information.

Indication of battery capacity / battery operation

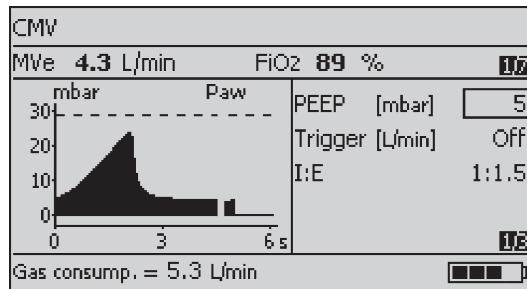

The remaining capacity of the battery is indicated by Oxylog 3000 *plus* in 25 % increments in the lower right section of the information window when power is ON.

As an example, in the above screen the battery is 75 % charged.

- The accuracy of the battery capacity indicator can vary, depending on the age and condition of the battery. Refer to "Technical Data" on page 139 for additional information.
- The capacity indication is overwritten when other messages need to be shown in the Information window.
- Additional alarms can draw attention to the remaining operating time of the battery. Refer to the table "Alarm - Cause - Remedy" on page 112.

For screen brightness during battery operation, refer to "Screen brightness" on page 81.

Determining the approximate pneumatic operating time

Example for supply of O₂:

- Cylinder pressure measured on the pressure gauge of the pressure reducer: 20,000 kPa (200 bar)
- Liquid capacity of the O₂ cylinder: 2.1 L

Supply of O₂:

2.1 L x 20,000 kPa = approx. 420 L at environmental pressure level.

Example for pneumatic operation time:

- VC-CMV mode, frequency 10 breaths/min, VT = 0.53 L, O₂ = 100 %
- Minute volume = 10 breaths/min x 0.53 L = 5.3 L/min

$$\text{Operation time} = \frac{\text{O}_2 \text{ supply [L]}}{(\text{MV} + 0.5^*) \text{ [L/min]}}$$

* Calculated with average gas consumption of ventilator: 0.5 L/min

$$\text{Operation time} = \frac{420}{5.8} = \text{approx. 72 minutes}$$

The pneumatic operation time increases when Oxylog 3000 *plus* operates with O₂ concentration of less than 100 % O₂, as ambient air is drawn into the device.

The amount of gas from the high-pressure supply, which is currently being consumed, is indicated by the Oxylog 3000 *plus* in the lower left section of the information window in L/min. This display is overwritten when a higher priority message is activated.

Example:

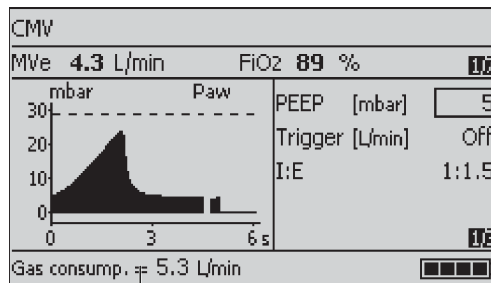

A

A O₂ consumption = 5.3 L/min

Checking readiness for operation

The device check should be performed:

- Before every use of the device if the breathing hose was changed.
- At least every six months.

The Oxylog 3000 *plus* interrupts the device check if a fault is detected.

The relevant fault is indicated on the screen.

WARNING

The patient may be endangered if the device check is not completed successfully.

Perform device check

The device check consists of the following steps:

- Connect the test lung
- Switch the device ON
- Check connections
- System check
- Power supply failure check.

The duration of the device check is approximately 3 minutes.

Connect the test lung

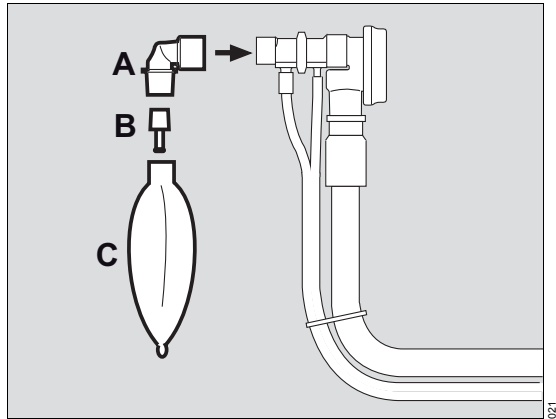



- 1 Make sure that the angled connector (A) is connected to the flow sensor.
- 2 Connect the catheter mount (B) of the test lung, diameter 7 mm, to the angled connector. The catheter mount simulates the resistance of the airways.
- 3 Connect the balloon (C) of the test lung. Refer to "List of Accessories" on page 167.

NOTE

BTPS values of a test lung are not the same as the BTPS values of a patient. The Oxylog 3000 *plus* measures and adapts according to BTPS values of a patient. Therefore, when a test lung is connected, the MVe and VTe indicated on display may differ from the MVe and VTe that is set by the operator.

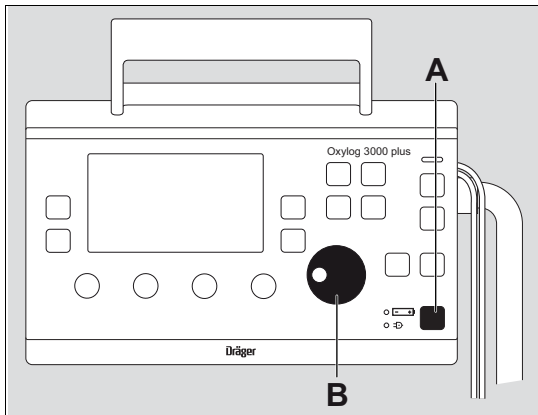
Switch the device ON



- 1 To switch the device ON briefly press the  key (A).

The device performs a selftest and the operator is prompted, on the display, to activate the configuration menu or device check:

Press rotary knob for device check and configuration

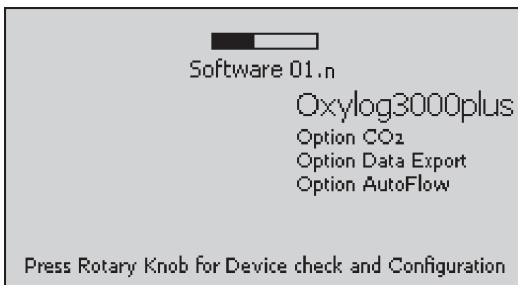

- 2 Press the rotary knob (B) to confirm, before the black progress bar is complete. The start-up screen appears:

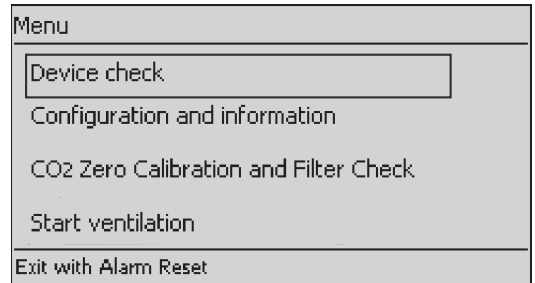

- 3 Select **Device check** in the start-up menu and confirm.

NOTE

The device check can be discontinued at any time by pressing the **Alarm Reset** key.

NOTE

During device check, the connections (gas supply, hose type) and the system (flow, pressure levels, alarm signals and knobs) are checked.

Check connections

- 1 Ensure that the gas supply has been connected.
- 2 Select and confirm the appropriate hose type.
- 3 Ensure that the test lung has been connected.

The Oxylog 3000 *plus* automatically checks if a test lung has been connected. The device check is interrupted if a test lung is not detected within one minute. The check is continued when the test lung is detected.

- 4 The Oxylog 3000 *plus* automatically checks if the detected hose differs from the selected hose type.

If the wrong hose type is selected:

- Press the **Alarm Reset** key to cancel the device check.
- Restart the device check.
- Select the correct hose type.

System check

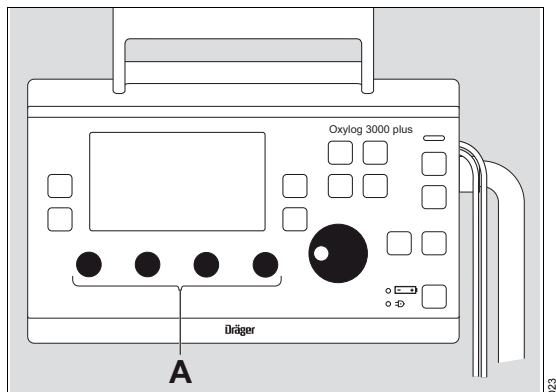

- 5 Set the control knobs (A) below the display to the required values.

The Oxylog 3000 *plus* successively activates the audible and optical alarm signals and prompts the operator to acknowledge each signal.

- 6 Confirm the audible and optical alarm signals. The device check continues automatically.

During the automatic test sequence, the Oxylog 3000 *plus* checks the flow, pressure levels and alarm signals. Corresponding sounds are heard.

The bar graph shows the progress made by the check.

The result is displayed on the last page of the device check screens. If all tests are completed successfully, the device will go to the last page. If a test fails, the device will go directly after the failed test to the last page, without performing the other tests.

After confirmation, the system returns to the menu screen.

If the service inspection date has been passed without servicing, the text **Service date overdue !** will appear in the window after finishing the device check. In this case the device must be serviced immediately.

High airway pressure and disconnection alarm check

Check the high airway pressure alarm

- 1 Ventilate the test lung in CMV mode.
- 2 Press the test lung manually, until the airway pressure exceeds the set Pmax.
- 3 Check if the **Paw high** alarm occurs.

Check the alarm in case of hose system disconnection

- 1 Ventilate the test lung in CMV mode.
- 2 Disconnect the breathing hose and/or flow measuring lines from the ventilator.
- 3 Check if an applicable alarm occurs.

Power supply failure check

A monthly check of the power supply failure alarm is recommended.

- 1 Switch the device on.
- 2 Disconnect the external power supply.
- 3 Remove the battery to activate the acoustic alarm signal.
- 4 Listen for the acoustic alarm signal.

NOTE

If no alarm is heard, contact DrägerService.

- 5 When the power supply failure alarm test is completed, reinstall the battery into the battery compartment of the Oxylog 3000 *plus*.
- 6 Connect the external power supply.

Troubleshooting

WARNING

The ventilator is ready for operation only after all functional tests have been successfully performed.

If the device check is not completed successfully:

- 1 Refer to "Error messages during the device check" on page 122 of the section "Problem Solving".
- 2 Contact your local DrägerService for support.

CO₂ zero calibration and filter check before ventilation (optional)

The CO₂ zero calibration and filter check only work if the CO₂ option has been installed and if the CO₂ sensor is present.

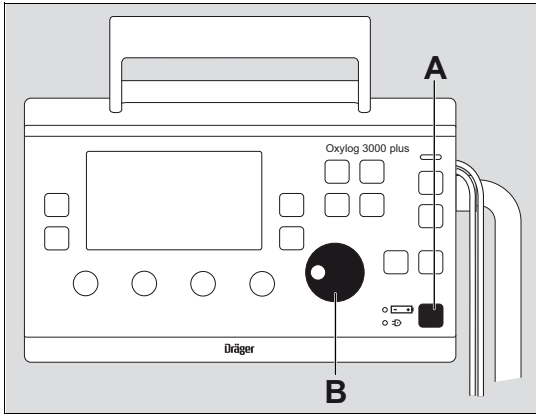

- 1 To switch the device ON briefly press the  key (A).

The device performs a selftest and the operator is prompted, on the display, to activate the configuration menu or device check:

Press rotary knob for device check and configuration

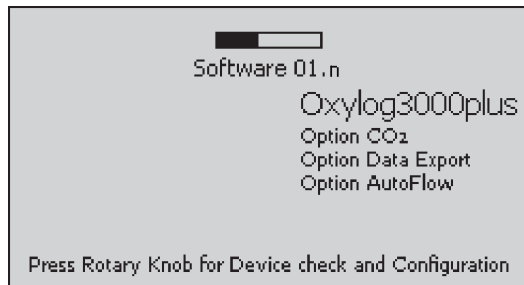

- 2 Press the rotary knob (B) to confirm, before the black progress bar is complete.

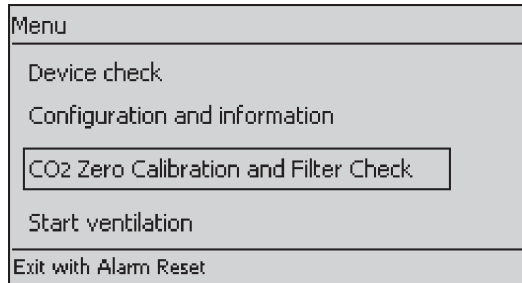

- 3 Select **CO₂ zero calibration and filter check** in the start-up menu and confirm.

The function **CO₂ Zero Calibration and Filter check** is displayed only if the option is available.

NOTE

The CO₂ zero calibration and filter check can be discontinued at any time by pressing the **Alarm Reset** key.

Zero calibration before ventilation

The zero calibration is performed with a clean CO₂ sensor that has been removed from the cuvette!

NOTE

Do not breathe on the CO₂ sensor during zero calibration, otherwise the zero calibration can fail or the zero calibration can pass with an invalid zero value.

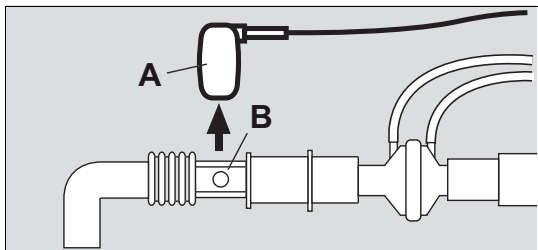

- 1 Remove the CO2 sensor (A) from the cuvette (B).

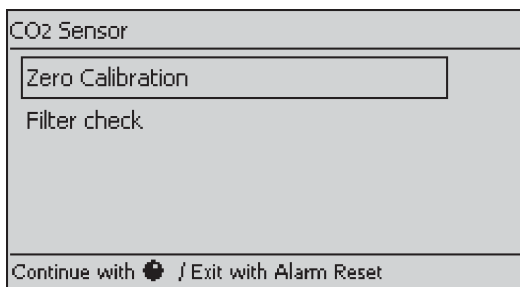

- 2 Select and activate **Zero calibration**. The screen displays the text **Remove sensor from cuvette. Confirm with rotary knob**.
- 3 Confirm. The zero calibration starts and the line displays **Zero calibration in progress**. After a successful zero calibration, the line briefly displays **Zero calibration OK**.
- 4 Press **Alarm Reset** to exit.
- 5 Attach the CO2 sensor back to the cuvette.

If zero calibration was not successful:

The Oxylog 3000 *plus* displays the alarm **Zero calibration failed**.

- Repeat zero calibration.

If zero calibration is still not possible:

- 1 Check whether the sensor (A) is soiled and clean it if necessary. If the sensor is defective, replace the sensor.
- 2 Repeat zero calibration.

CO2 filter check before ventilation

NOTE

Before the CO2 filter check, you need to have finished a successful CO2 zero calibration. Otherwise the CO2 filter check may be outside of the tolerance range.

- 1 Remove the CO2 sensor (A) from the cuvette (B).

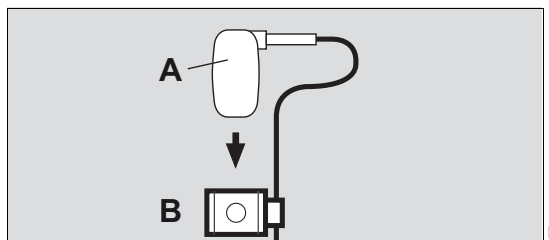

- 2 Attach the CO2 sensor (A) to the test filter (B).
- 3 Select **Filter check**.
- 4 Confirm. The filter check starts and the screen displays **Filter check in progress**. After a successful filter check, the line briefly displays **Filter check OK**.
- 5 Press **Alarm Reset** to exit.
- 6 Attach the CO2 sensor back to the cuvette.

If the check was not successful:

The Oxylog 3000 *plus* displays the alarm **Filter check failed**. The test value is outside the permissible tolerance.

- Check whether the sensor (A) or test filter (B) is soiled and clean them if necessary. Repeat the CO2 filter check.

If the check was still not successful:

- Check the CO2 calibration with test gas.

For connecting the CO2 sensor and cuvette see page 48. For CO2 zero calibration and filter check during ventilation, see page 91. For CO2 measurement see page 91. For CO2 configuration in the Customer Service Mode see page 105.

Preparation for use after system check, CO₂ zero calibration and filter check

- 1 Assemble the Oxylog 3000 *plus* for operation. Refer to "Assembly" on page 35.
- 2 Connect to the power supply and gas supply. Refer to "Internal rechargeable battery" on page 37 and "Connecting the gas supply" on page 41.
- 3 Start the ventilator:

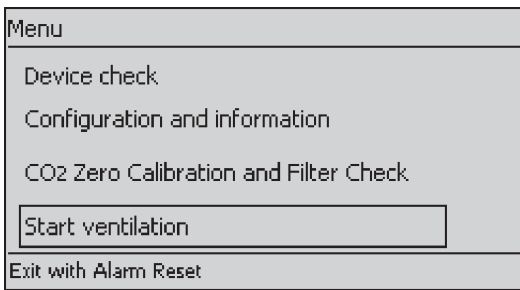

- Select **Start ventilation** from the menu and confirm.
- Or
- Press the **Alarm Reset** key.

Operation

Starting operation	62
Switch the device ON	62
Preparing ventilation mode	64
To activate a ventilation mode	64
Setting ventilation parameters	64
VC-CMV, VC-AC	65
Trigger (VC-AC)	66
Setting AutoFlow (optional)	67
Cardio-pulmonary resuscitation (CPR)	67
VC-SIMV, VC-SIMV/PS	68
Setting Pressure Support VC-SIMV/PS	69
Setting AutoFlow (optional)	70
PC-BIPAP, PC-BIPAP/PS	71
Setting Pressure Support PC-BIPAP/PS	72
SpnCPAP, SpnCPAP/PS	73
Apnoea ventilation	74
Setting Pressure Support Spn-CPAP/PS	75
Cardio-pulmonary resuscitation (CPR)	75
NIV – Non-invasive ventilation (Mask ventilation)	76
Special functions	77
Manual inspiration / Inspiration hold	77
100 % O2 (optional)	77
O2 inhalation (optional)	77
O2 concentration with "O2 blending"	79
Setting HME correction	80
Calibration	81
Screen brightness	81
Alarm volume	81
Shutdown	82

Starting operation

The actual screen display may differ in appearance or configuration.

WARNING

Only use a ventilator that has been cleaned, disinfected and successfully tested to be ready for operation, to prevent a health risk for the patient and user.

Refer to the chapter "Cleaning, Disinfection and Sterilization" on page 123.

CAUTION

When using the ventilator in very low ambient temperatures, always consider that the cold gas will expand due to the warming by the patients body. Carefully monitor the *MVe*.

Risk of hyperventilation.

CAUTION

In very high ambient temperatures, avoid mixing with ambient air: always set *FiO2* to 100 % O₂.

Exposing the patient to very warm inspiratory gas may cause lung damage.

Switch the device ON

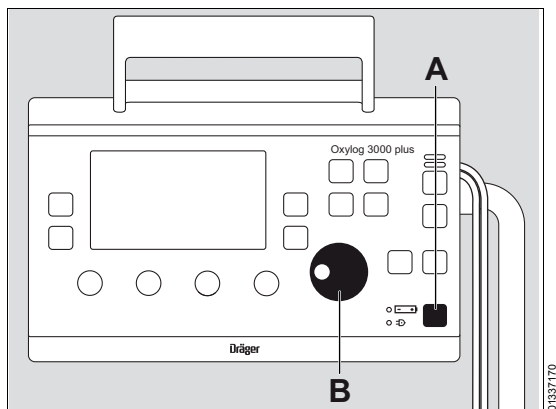

- To switch the device ON, briefly press the  key (A).

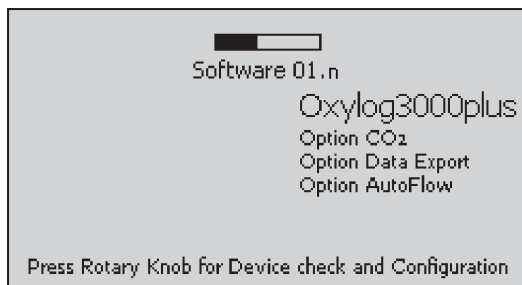

The Oxylog 3000 *plus* performs a selftest. The selftest will be completed in approximately six seconds.

During the selftest, the system briefly displays the starting page with a bar graph indicating the progress of the selftest, the software version, the activated software options and a prompt for the operator to activate the device check by pressing the rotary knob (B).

If the rotary knob (B) is not pressed during the self-test, the hose selection page is displayed.

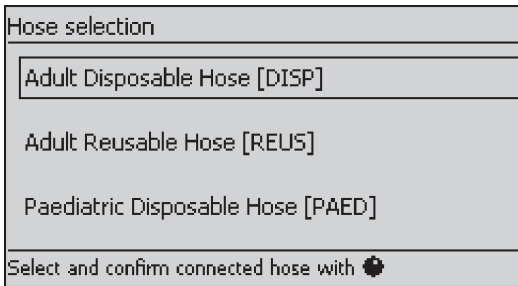

Select the connected hose type, as seen in the above graphic, by rotating the rotary knob (B) and confirm by pressing the rotary knob (B). The ventilator now automatically begins ventilation with the default settings.

NOTE

As long as the hose selection page is shown, the patient is not being ventilated.

NOTE

The request to select the hose type can be configured. Refer to "Customer Service Mode" on page 98.

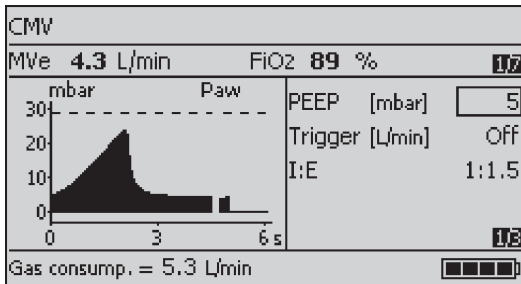

Starting screen with default settings.

The default settings can be configured in Customer Service Mode. Refer to "Set start-up settings" on page 100.

Preparing ventilation mode

To activate a ventilation mode

- 1 Press and hold a ventilation mode key for approximately 3 seconds.
Or
- 2 Press a ventilation mode key and confirm by pressing the rotary knob.

The new ventilation mode selected is now effective.

For an overview of all ventilation modes, refer to "Range of functions" on page 22. For a detailed explanation on all ventilation modes, refer to "Principles of Operation" on page 157.

Setting ventilation parameters

- 1 Set the required control knob below the display.
Or
- 2 Select, set and confirm a parameter on the display with the rotary knob.

If the changed settings are not confirmed after 5 seconds, the alarm **! Confirm settings** appears. If the settings are still not confirmed after 10 seconds, the alarm **! Settings not confirmed** appears. After that the former settings are restored.

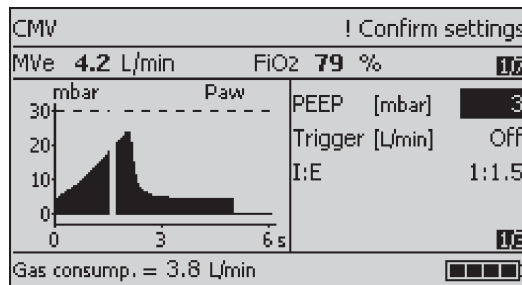

When the PEEP setting is increased above 10 mbar, a message **Confirm PEEP above 10 mbar?** will appear to request confirmation of the change. The PEEP setting can be increased to the desired setting after the message is confirmed with the rotary knob.

The device can be configured to show **Ti** or **I:E** as a primary parameter that can be set. If **Ti** is configured as the primary parameter, **I:E** will be shown in the information window when **Ti** is selected, and vice versa. This configuration will apply to all ventilation modes. Refer to the "Customer Service Mode" on page 98.

VC-CMV, VC-AC

VC-CMV -Volume Controlled - Controlled Mandatory Ventilation

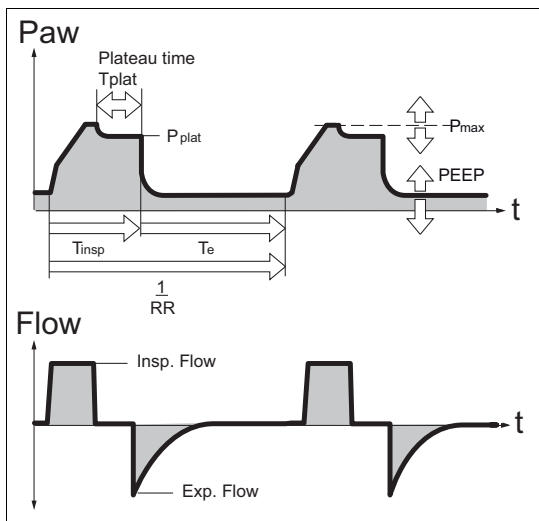

Volume-controlled ventilation with fixed mandatory minute volume MV, which is set with tidal volume **VT** and respiratory rate **RR**.

WARNING

Only use VC-CMV for patients who are not spontaneously breathing. Otherwise, the patient may be put at risk by not receiving sufficient ventilation.

Use VC-AC for patients with partial spontaneous breathing.

Set the ventilation pattern with the controls below the display:

- Tidal volume **VT**.
- Ventilation respiratory rate **RR**. (minimum possible frequency: 5 per min).
- Maximum airway pressure **Pmax**.
- O₂ concentration **FiO₂**.

The following can be set on the display:

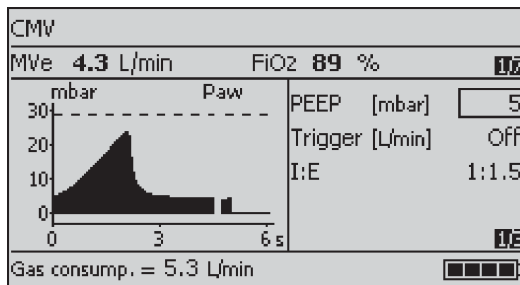

- Positive end expiratory pressure **PEEP**.
- Sensitivity **Trigger**.
- Ventilation time ratio **I:E** or inspiratory time **Ti**.

When setting the ventilation respiratory rate **RR**, tidal volume **VT** or **I:E / Ti**, the associated values for inspiration flow and **Ti / I:E** are automatically displayed in the information window.

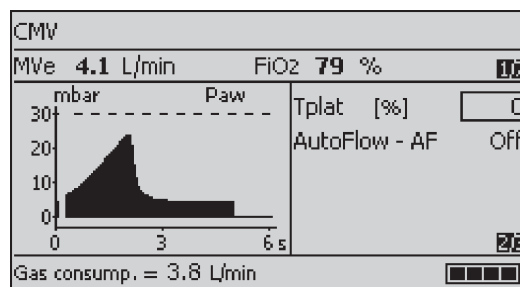

- Plateau time **Tplat** %, in % of the inspiratory time.
- **AutoFlow** (optional).

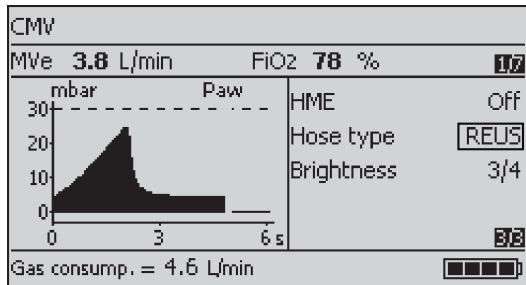

Trigger (VC-AC)

NOTE

When in VC-CMV and the trigger is set to a value, the ventilation mode changes to VC-AC.

VC-AC –Volume Controlled - Assist Control

For synchronization with the patient's spontaneous inspiratory efforts.

The mandatory breaths are synchronized with the patient's spontaneous inspiratory efforts when the trigger is activated and the trigger sensitivity is set.

In this case, the actual respiratory rate may be higher than the set ventilation respiratory rate **RR**.

Successful patient triggering is briefly indicated by an asterisk (*) on the left side of the curve window.

– Hose type

The selected hose type must match the hose type in use. Otherwise a correct volume measurement cannot be guaranteed.

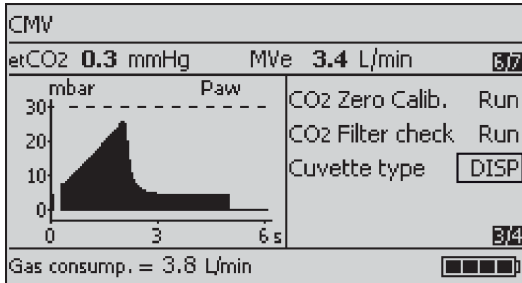



– Cuvette type (optional)

NOTE

The cuvette windows of the reusable cuvette and disposable cuvette have different optical properties. Therefore, the correct cuvette type must be selected in the Setting menu. Otherwise the zero point is shifted by up to ± 8 mmHg of CO₂.

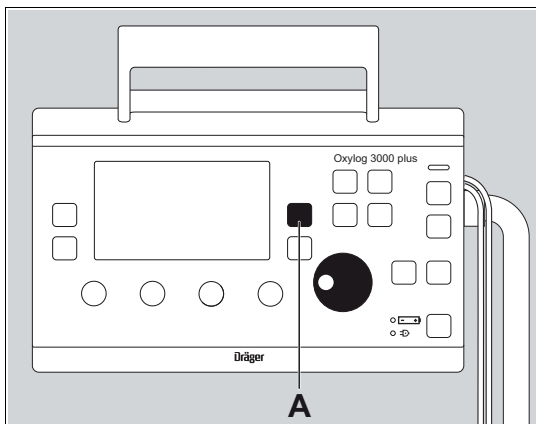
Activating/setting the trigger



- 1 Press the key **Settings**  (A) until the trigger parameter is displayed.
- 2 Select the line **Trigger** on the display and then set and confirm the value with the rotary knob. Small value = high sensitivity.

The ventilation mode **AC** is shown on the display.

Deactivating trigger

- 1 Set a value less than 1 L/min or greater than 15 L/min (**off** is displayed instead of a value).
- 2 Press the rotary knob to confirm.

The last effective trigger value is adopted by the ventilator when changing from VC-AC to PC-BIPAP or SpnCPAP.

Setting AutoFlow (optional)

The following can also be set on the display for VC-CMV and VC-AC:

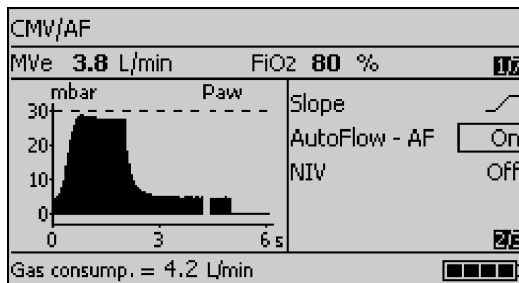

- The AutoFlow function **AutoFlow-AF**.

When AutoFlow is switched on, the setting **Tplat%** is no longer valid, and **Slope** must be set.

For more information on AutoFlow, refer to "AutoFlow" on page 162.

Cardio-pulmonary resuscitation (CPR)

During CPR, the airway pressure **Paw** is increased because of chest compressions.

The Oxylog 3000 *plus* will try to limit the airway pressure **Paw** to the set **Pmax**, without ending the inspiration prematurely.

However, if due to compressions the airway pressure **Paw** exceeds the set **Pmax** by 5 mbar, the Oxylog 3000 *plus* cycles to the expiratory phase.

Therefore in general, if **Pmax** is set to a higher value, a higher minute volume is possible. However, this increases the intra-thoracic pressure and may reduce coronary perfusion.

VC-SIMV, VC-SIMV/PS

Volume Controlled - Synchronized Intermittent Mandatory Ventilation

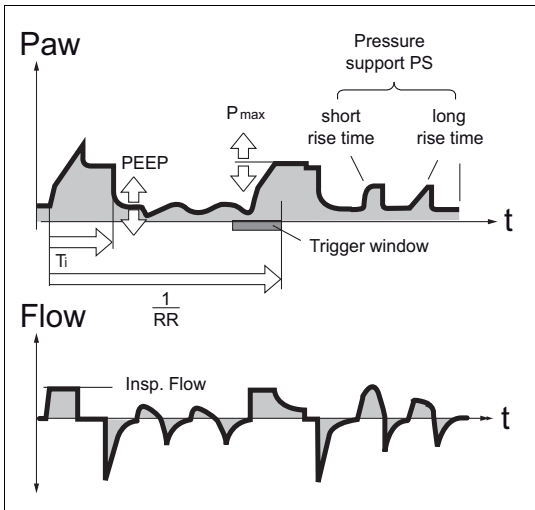

For patients with inadequate spontaneous breathing, or for patients who are to be weaned gradually.

Fixed mandatory minute volume MV is set with tidal volume VT and ventilation respiratory rate RR. The patient can breathe spontaneously between the mandatory breaths and thus contribute to the total minute volume. Spontaneous breathing can be assisted with PS.

Set the ventilation pattern with the controls below the display:

- Tidal volume **VT**.
- Respiratory rate **RR**.
(minimum possible respiratory rate: 2 per min).
- Maximum airway pressure **Pmax**.
- O2 concentration **FiO2**.

The following can be set on the display:

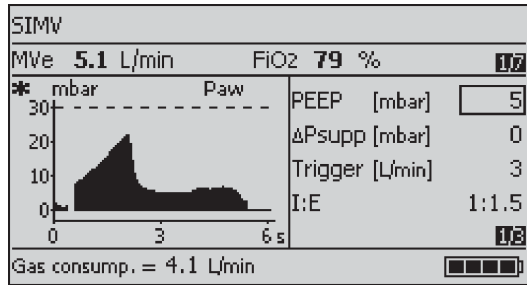

- Positive end expiratory pressure **PEEP**.
- Pressure Support ΔP_{supp} above PEEP.
- Sensitivity **Trigger**.

Successful patient triggering is indicated by an asterisk (*) on the left side of the curve window.

- Ventilation time ratio **I:E** or inspiratory time **Ti**.

When setting the ventilation respiratory rate RR, tidal volume VT or I:E / Ti, the associated values for inspiration flow and Ti / I:E are automatically displayed in the information window.

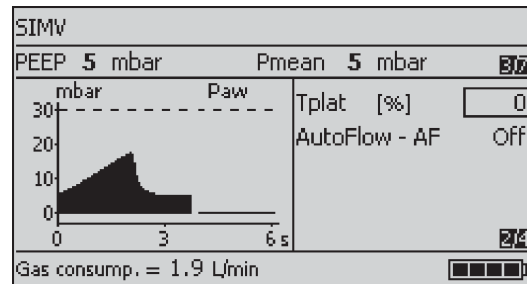

- Plateau time **Tplat** %, in % of the inspiratory time.
- **AutoFlow** (optional).

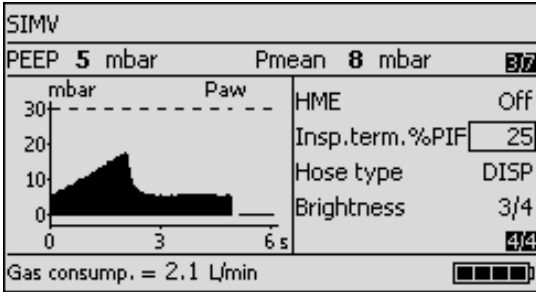

- **Insp.term.%PIF**
Inspiration termination criteria of pressure supported strokes, as percentage of the peak inspiratory flow (PIF).
- **Hose type**
The selected hose type must match the hose type in use. Otherwise a correct volume measurement cannot be guaranteed.

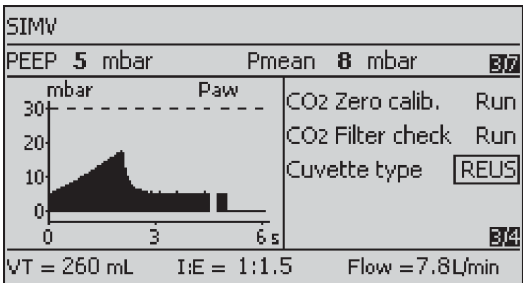

- **Cuvette type** (optional)

NOTE

The cuvette windows of the reusable cuvette and disposable cuvette have different optical properties. Therefore, the correct cuvette type must be selected in the Setting menu. Otherwise the zero point is shifted by up to ± 8 mmHg of CO₂.

Setting Pressure Support VC-SIMV/PS

The following can also be set on the display for VC-SIMV:

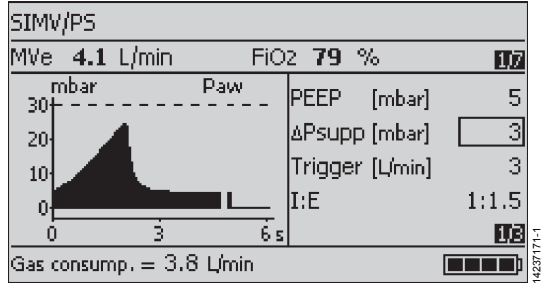

- Setting on page 1: Pressure Support ΔP_{supp} above PEEP.
- Setting on page 2: When ΔP_{supp} is set above 0 mbar, the pressure rise time **Slope** can be set.
 - Flat slope = long pressure rise time
 - Medium slope = medium pressure rise time
 - Steep slope = short pressure rise time.

Setting AutoFlow (optional)

The following can also be set on the display for VC-SIMV and VC-SIMV/PS:

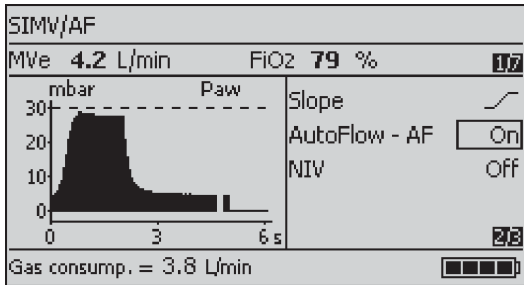

– The AutoFlow function **AutoFlow-AF**.

When AutoFlow is switched on, the setting **Tplat%** is no longer valid, and **Slope** must be set.

For more information on AutoFlow, refer to "AutoFlow" on page 162.

PC-BIPAP, PC-BIPAP/PS

Pressure Controlled - Biphasic Positive Airway Pressure

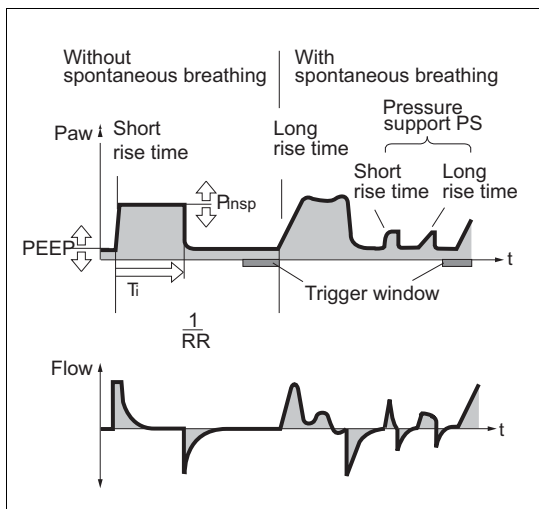

Pressure-controlled ventilation combined with spontaneous breathing throughout the respiratory cycle and variable Pressure Support at CPAP level.

For patients without spontaneous breathing, to spontaneously breathing patients shortly before extubation. The patient is weaned by gradually reducing the mandatory portion of the total minute volume MV and by reducing the Pressure Support ΔP_{supp} .

The mandatory portion of the total minute volume MV is set via the inspiratory pressure P_{insp} , PEEP and ventilation respiratory rate RR .

Refer to the description on page 161 for details.

Set the ventilation pattern with the controls below the display:

- Respiratory rate RR .
- Maximum airway pressure P_{max} .
- O₂ concentration FiO_2 .

The following can be set on the display:

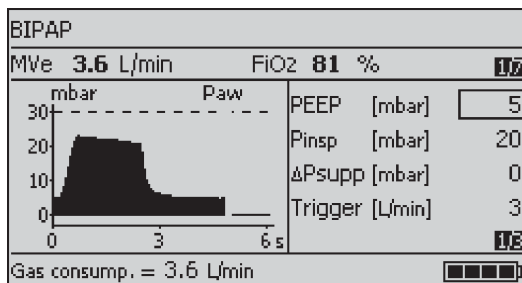

- Positive end expiratory pressure **PEEP**.
- Inspiratory pressure **P_{insp}** .
- Pressure Support ΔP_{supp} above PEEP.
- Sensitivity **Trigger**.
Successful patient triggering is indicated by an asterisk (*) on the left side of the curve window.

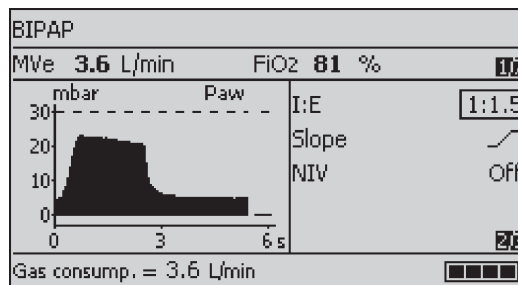

- Ventilation time ratio **I:E** or inspiratory time **T_i** .
- Pressure rise time **Slope** (effective for the PC-BIPAP stroke and Pressure Support ΔP_{supp}).
- **NIV** - Non-invasive ventilation.
Refer to "NIV – Non-invasive ventilation (Mask ventilation)" on page 76.

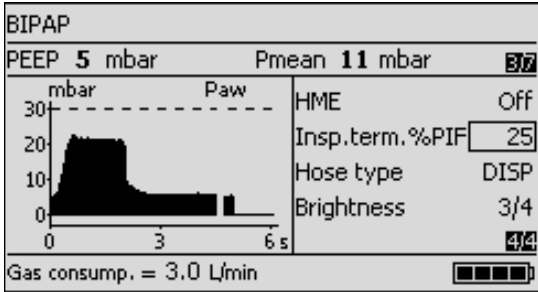

- **Insp.term.%PIF**
Inspiration termination criteria of pressure supported strokes, as percentage of the peak inspiratory flow (PIF).
- **Hose type**
The selected hose type must match the hose type in use. Otherwise a correct volume measurement cannot be guaranteed.

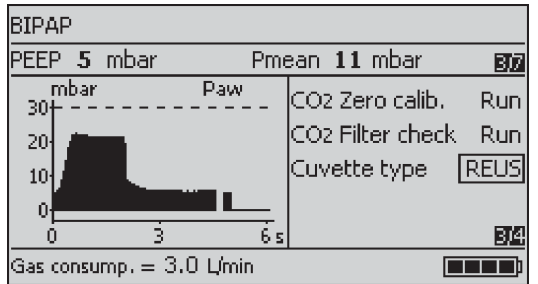

- **Cuvette type** (optional)

NOTE

The cuvette windows of the reusable cuvette and disposable cuvette have different optical properties. Therefore, the correct cuvette type must be selected in the Setting menu. Otherwise the zero point is shifted by up to ± 8 mmHg of CO₂.

Setting Pressure Support PC-BIPAP/PS

The following can also be set on the display for PC-BIPAP:

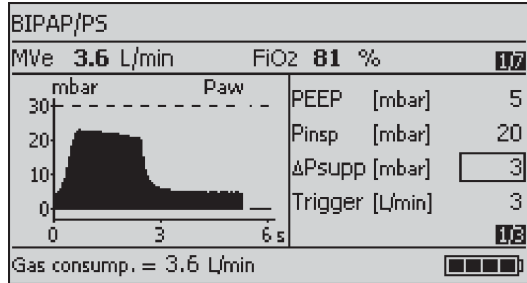

- Setting on page 1: Pressure Support ΔP_{supp} above PEEP.
- Setting on page 2: Pressure rise time **Slope**.
 - Flat slope = long pressure rise time
 - Medium slope = medium pressure rise time
 - Steep slope = short pressure rise time.

SpnCPAP, SpnCPAP/PS

Spontaneous Continuous Positive Airway Pressure

WARNING

Only use SpnCPAP (/PS) for patients with sufficient spontaneous breathing.

Otherwise there is a risk of the patient receiving insufficient ventilation.

Set the ventilation pattern with the controls below the display:

- Maximum airway pressure ***P_{max}***.
- O₂ concentration ***FiO₂***.

The following can be set on the display:

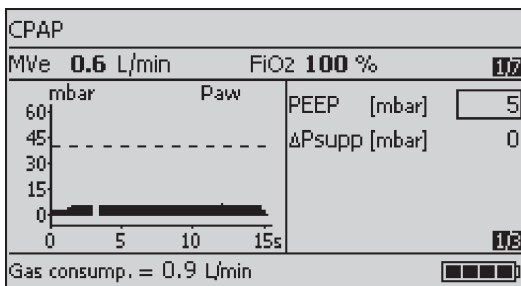

- Positive end expiratory pressure ***PEEP***.
- Pressure Support ***ΔP_{supp}*** above PEEP.
- ***NIV*** - Non-invasive ventilation. Refer to "NIV – Non-invasive ventilation (Mask ventilation)" on page 76.

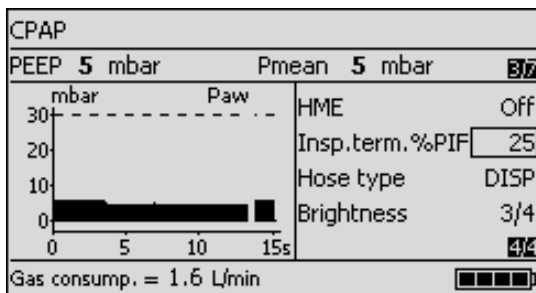

- ***Insp.term.%PIF***
Inspiration termination criteria of pressure supported strokes, as percentage of the peak inspiratory flow (PIF).
- ***Hose type***
The selected hose type must match the hose type in use. Otherwise a correct volume measurement cannot be guaranteed.

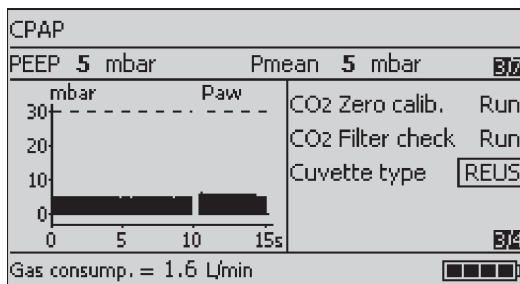

- ***Cuvette type*** (optional)

NOTE

The cuvette windows of the reusable cuvette and disposable cuvette have different optical properties. Therefore, the correct cuvette type must be selected in the Setting menu. Otherwise the zero point is shifted by up to ± 8 mmHg of CO₂.

Apnoea ventilation

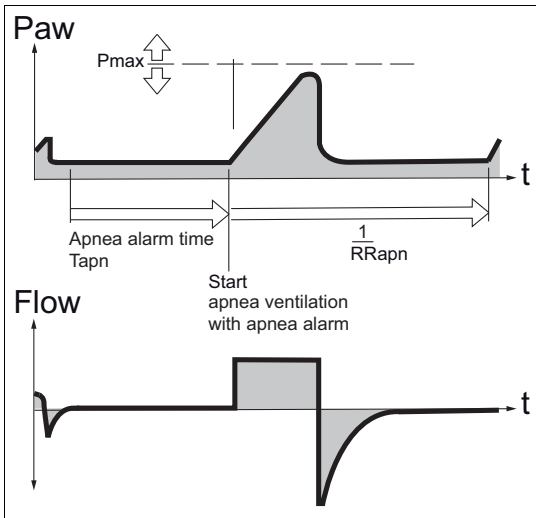

Apnoea back-up ventilation is only applicable when using the SpnCPAP mode. In the event of an apnoea, the ventilator will automatically activate volume-controlled mandatory ventilation - (VC-CMV).

When an apnoea occurs, the device simultaneously issues an alarm signal and switches to volume controlled ventilation with the parameters respiratory rate RR_{apn} , tidal volume V_{Tapn} , and the maximum airway pressure P_{max} when the apnoea time T_{apn} has been reached. The ventilation time ratio I:E = 1:1.5 and the plateau time $T_{plat} \% = 0$ are preset during apnoea ventilation.

Setting apnoea ventilation

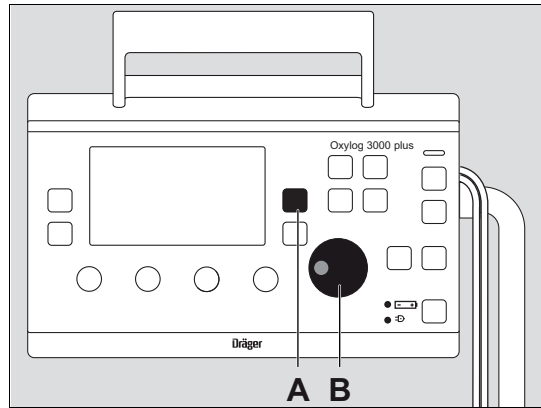

On the display:

- Set **T_{apn}** with the rotary knob (B) to a value between 15 and 60 seconds.

The parameters RR_{apn} and V_{Tapn} , which are required for setting apnoea ventilation, are now displayed:

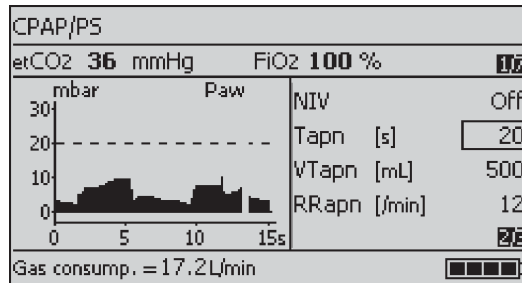

- 3 Set RR_{apn} and V_{Tapn} .
- 4 Set P_{max} . This determines the maximum airway pressure allowed during apnoea ventilation.

To end apnoea ventilation

- Press the **Alarm Reset** key.

The ventilator resumes ventilating with the original mode and parameter settings.

To deactivate apnoea ventilation

- Set **Tapn** to OFF.

NOTE

Apnoea ventilation can only be activated in the ventilation mode SpnCPAP without NIV.

The minimum ventilation required by the patient must be monitored via the lower alarm limit $MVe \sqrt{\quad}$.

Cardio-pulmonary resuscitation (CPR)

Refer to "Cardio-pulmonary resuscitation (CPR)" on page 67.

Setting Pressure Support Spn-CPAP/PS

If ΔP_{supp} is set above 0 mbar, the following can also be set on the display for SpnCPAP:

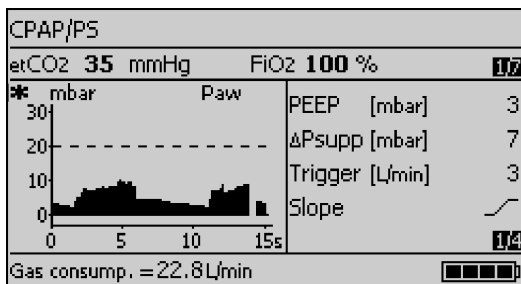

- Sensitivity **Trigger**.
Successful patient triggering is indicated by an asterisk (*) on the left side of the curve window.
- Pressure rise time **Slope** (effective for Pressure Support ΔP_{supp}).

NIV – Non-invasive ventilation (Mask ventilation)

Use of NIV

NIV can only be activated as a supplementary function in the ventilation modes SpnCPAP (/PS), PC-BIPAP (/PS), VC-CMV / AF, VC-AC / AF and VC-SIMV / AF. The Oxylog 3000 *plus* automatically adjusts to the requirements of mask ventilation. Mask leakages are detected by the device and compensated for. Therefore, the displayed measured values VTe and MVe do not include the leakage. The leakage alarm is inactive.

WARNING

If NIV is not activated, measured values for VTe and MVe will be inconsistent if there are leakages during ventilation.

WARNING

Ensure that NIV is not activated for intubated patients.

Risk of undetected leakages and inadequate ventilation.

WARNING

Bacterial filters, HME and masks increase the resistance and dead space volume of the ventilation equipment. Note the manufacturer's directions.

Risk of CO₂ rebreathing.

WARNING

Check MVe alarm limits after deactivating NIV mode.

WARNING

Avoid high airway pressure.

Risk of aspiration.

To switch on NIV

- 1 Activate **NIV off**.
 - 2 Select **NIV on** and confirm.
- The supplement NIV appears in the ventilation mode window.

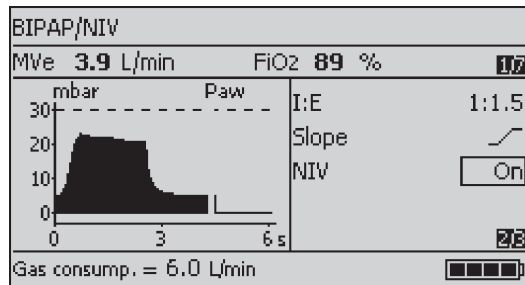

WARNING

Set the lower alarm limit MVe ∇ according to the minimum ventilation required for the patient.

Otherwise, there is a risk of the patient receiving insufficient ventilation.

NOTE

Apnoea ventilation is not possible when NIV is active.

Special functions

Manual inspiration / Inspiration hold

The function Manual inspiration / Inspiration hold will either initiate a new (manual) breath or hold the inspiratory phase of the current breath for a maximum of 15 seconds.

The pattern of the manually started breath corresponds with the set ventilation mode.

This function is not available for:

- SpnCPAP without PS,
- O₂ inhalation (optional).

To activate Manual inspiration or Inspiration hold

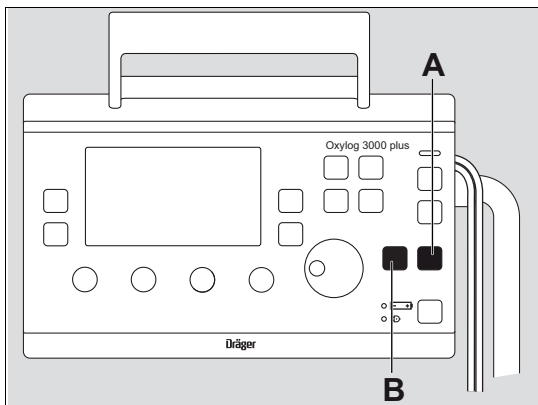

- Press key **Inspiration hold** (A) for as long as inspiration is required.

100 % O₂ (optional)

To apply 100 % O₂ for 3 minutes regardless of the momentarily set value.

- Briefly press key **100 % O₂** (B).
Its indicator lights up for 3 minutes.

The set value is resumed by the ventilator upon expiry of these 3 minutes, or when the **100 % O₂** is pressed again. The indicator dims.

O₂ inhalation (optional)

WARNING

The O₂ inhalation function is not a ventilation mode.

It may only be used for patients with spontaneous breathing who receive a constant O₂ flow of between 0 and 15 L/min via a mask.

If a tracheal stenosis or other obstruction occurs, the flow is interrupted by the ventilator for 5 seconds at an airway pressure of 30 mbar and the airway pressure is reduced to 0 mbar. The !!! **Paw high** alarm is active.

NOTE

The options 100 % O₂ and O₂ inhalation are mutually exclusive.

To activate O₂ inhalation

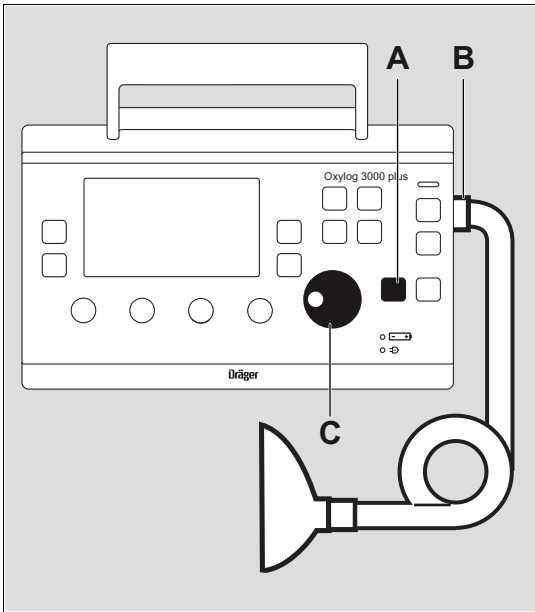

08337770

- 1 Connect the inhalation mask to the gas outlet for breathing hose (B).
- 2 Press and hold key **O₂ inhalation** (A) for approx. 3 seconds.
 O₂ inhalation is performed with the previously effective setting.
- 3 Set and confirm the required O₂ flow via the rotary knob (C).

Display (example):

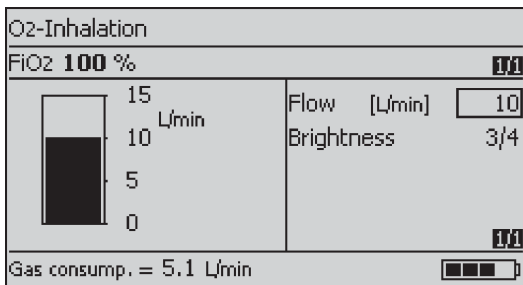

07137770

O₂ concentration with "O₂ blending"

The FiO₂ can be set between 40 % and 100 % O₂, regardless of the ventilation mode. An inspiratory O₂ concentration below 100 % is produced by drawing in ambient air, with the injector principle realized in the Oxylog 3000 *plus*.

However, the O₂ concentration which can be realized depends on the mean airway pressure and the inspiratory flow. The O₂ concentration can never be lower than 40 %.

This is shown in the following graphics:

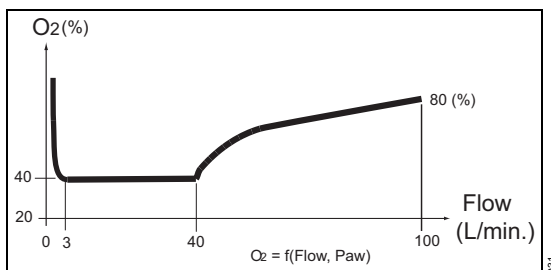

O₂ concentration which can be realized at a P_{mean} of 5 mbar.

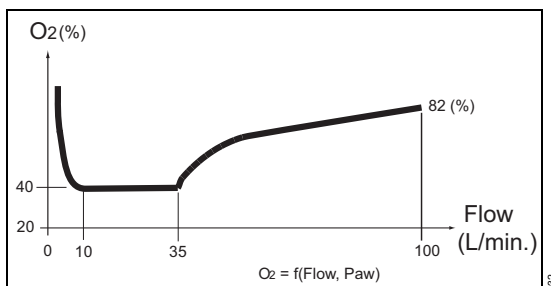

O₂ concentration which can be realized at a P_{mean} of 15 mbar.

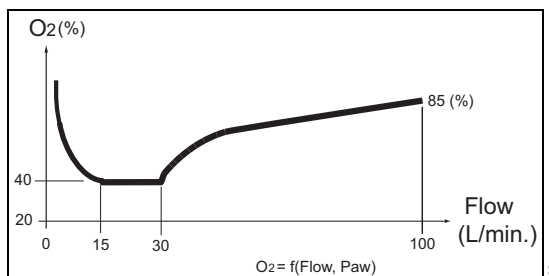

O₂ concentration which can be realized at a P_{mean} of 30 mbar.

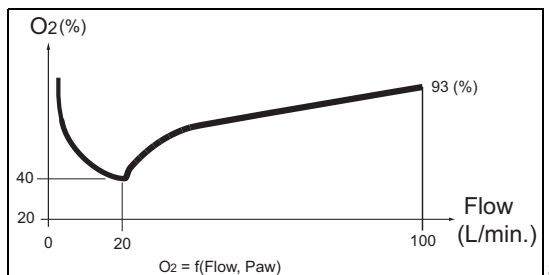

O₂ concentration which can be realized at a P_{mean} of 60 mbar.

The O₂ concentration is a calculated value. It is not measured by an internal O₂ sensor.

If the Oxylog 3000 *plus* cannot achieve the set O₂ concentrations, the signal "**Check settings FiO₂**" prompts the user to correct the setting.

- Correct setting by control **FiO₂**

When the O₂ concentration has been set, the value will be displayed after approximately 30 seconds.

When patients are breathing spontaneously, the achievable O₂ concentration will depend on the profile of the inspiratory flow.

WARNING

In toxic surroundings:

- The patient must be ventilated with 100 % medical grade oxygen so that toxic constituents do not enter into the breathing gas.
- The patient must be immediately transferred to a breathable atmosphere in order to prevent inhalation of toxic air when spontaneous breathing resumes.

WARNING

In infectious environments:

- The patient must be ventilated with 100 % medical grade oxygen so that bacteria, viruses, fungi or spores do not enter the breathing gas.
- The patient must be immediately transferred to a breathable atmosphere in order to prevent inhalation of infectious air when spontaneous breathing resumes.

Setting HME correction

The temperature and moisture influence of HME have an effect on the flow measurement. The Oxylog 3000 *plus* can compensate for the presence of an HME.

When using HME, select, set and confirm **HME - On** in the Settings window with the rotary knob.

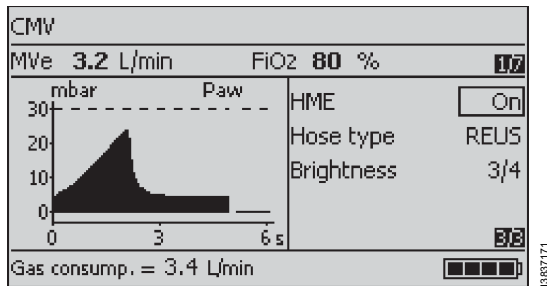

When **HME - ON** is selected, the flow sensor expects an expiration gas temperature of 35 °C and a relative humidity of 0 %.

When **HME - Off** is selected, the flow sensor expects an expiration gas temperature of 37 °C and a relative humidity of 100 %.

Calibration

The pressure and flow sensors are automatically calibrated by the device at regular intervals without interrupting ventilation.

The saved calibration values are retained even when the device is switched OFF.

The CO₂ sensor must be calibrated if the test values are not adhered to during the test gas check.

For calibrating CO₂ sensor, refer to "Customer Service Mode" on page 98.

Screen brightness

The screen brightness level can be set on the last page of the **Settings** menu, from level 1/4 to 4/4.

During battery operation, when no controls have been set for a period longer than one minute, the screen will automatically be dimmed (power save mode).

The screen brightness level in power save mode can be adjusted in Customer Service Mode. Refer to "Customer Service Mode" on page 98.

Alarm volume

The alarm volume level can be set on the last page of the **Alarms** menu, from level 1/4 to 4/4.

Shutdown

- After disconnecting the patient
Switch the device OFF:

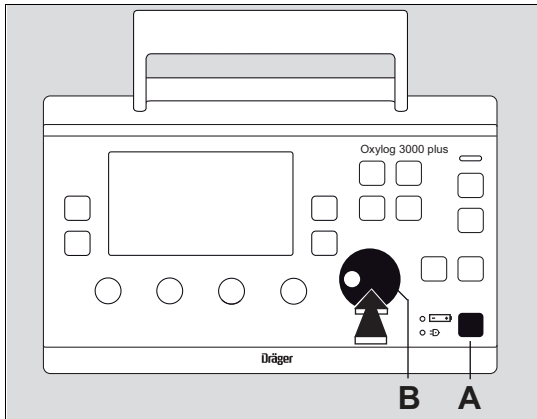

- 1 To switch the device OFF, hold down the  key (A) for approximately 3 seconds.

Ventilation is now stopped and a high-priority alarm is issued.

This alarm can be silenced with the  key.

- 2 Either:
 - Press the rotary knob (B) to confirm switch off.
- Or
 - Press the  key (A) to resume ventilation with the previous settings.

NOTE

When the device is switched OFF, the battery is still being charged if the device is connected to an external power source.

When O₂ is supplied from a cylinder:

- 3 Close the cylinder valve.

WARNING

The cylinder valve must be closed completely to avoid gas flow leakage by the device.

When O₂ is supplied from the pipeline system:

- 4 Disconnect the high-pressure connection from the source.
- 5 Disconnect the breathing hose.

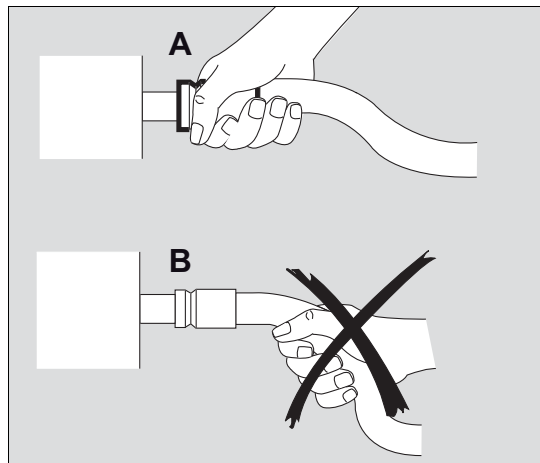

CAUTION

When disconnecting the breathing hose, always grip the sleeve (A) and not the corrugations (B).

If this is not done, the corrugations or hose may be torn from the sleeve.

Alarms

Types of alarms	84
In the event of an alarm	85
Setting alarm limits	87

Types of alarms

The actual screen display may differ in appearance or configuration from these illustrations.

The Oxylog 3000 *plus* assigns a priority to the alarm message. This message highlights the text with the appropriate number of exclamation marks and generates different tone sequences for the respective alarms.

!!! = Warning

!! = Caution

! = Advisory

Refer to the list "Alarm - Cause - Remedy" on page 112 for information on how to remedy the alarms.

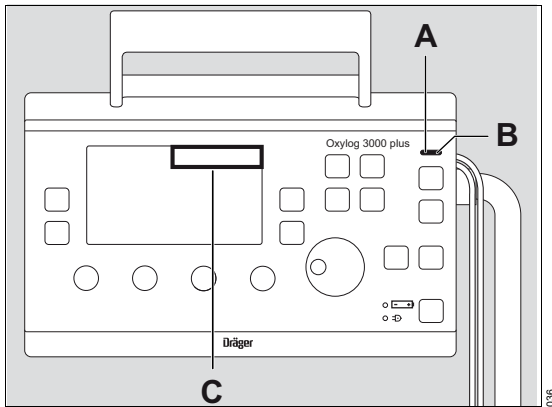

Caution

An alarm of medium priority.

- The alarm indicator (A) flashes yellow.

Caution messages are preceded by two exclamation marks.

Example: **!! No int. battery ?**

- The Oxylog 3000 *plus* generates a three-tone sequence, which is repeated approximately every 20 seconds.

Advisory

An alarm of low priority.

- The yellow alarm indicator (A) lights up.

Advisory messages are preceded by one exclamation mark.

Example:

! Settings not confirmed

- The Oxylog 3000 *plus* generates a 2-tone alarm sequence, which sounds only once.

Warning

An alarm with high priority

- The alarm indicator (B) flashes red.

Warnings are preceded by three exclamation marks and displayed in inverted form (C).

Example: **!!! Apnoea ventilation**

- The Oxylog 3000 *plus* generates a sequence of five tones, which sound twice and are repeated approximately every 7 seconds.

In the event of an alarm

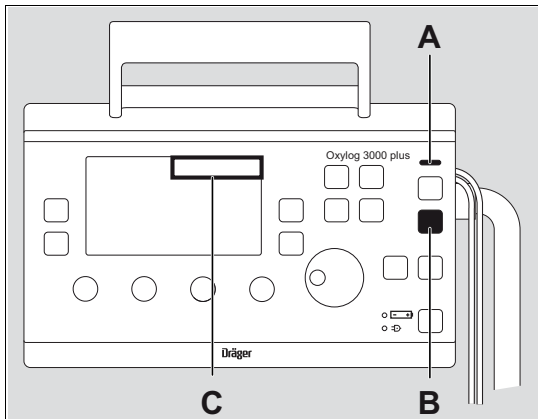

- The indicator (A) flashes red or yellow, or lights up yellow.
And
- The alarm message appears on the upper right corner of the screen (C). In addition, alarm tones are issued.

When the fault has been remedied the alarm tone is canceled.

Alarms, which have been remedied and remain on the display, can be acknowledged (reset):

- Press the **Alarm Reset** key (B).
The alarm message is now removed from the display.

Every alarm which has been remedied, but not acknowledged, will be overwritten when a new alarm is issued.

Suppress alarm tones

WARNING

Check the display regularly for alarm messages when the alarm tones are silenced.
Otherwise, alarms can be missed.

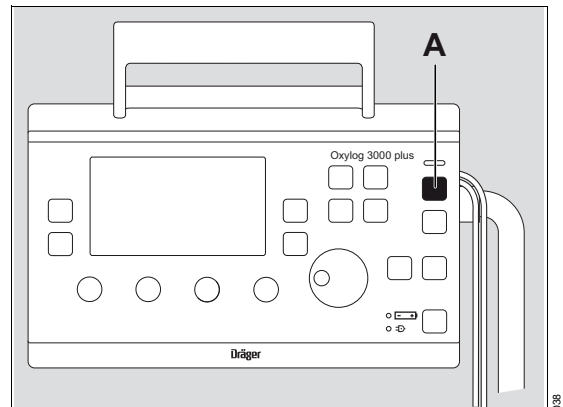

- 1 Press the key  (A).
The alarm indicator remains active and all current alarm tones are suppressed for approximately 2 minutes. Alarms with a higher priority override the alarm silence and sound with a tone sequence.
All alarm tones are resumed by the device after these 2 minutes.

WARNING

Set the alarm volume to a suitable level for the environment.

WARNING

Pay additional attention in environments where the surrounding noise interferes with hearing the maximum alarm tone of the device (e.g. in a helicopter).

NOTE

To be notified of new acoustic alarm signals, the 2 minutes alarm silence must be reset.

NOTE

The volume of alarm tones can be adjusted. Refer to section "Alarm volume" on page 81.

If alarm tones are to be heard again before the 2 minutes have expired:

- 2 Press the key  (A) again.

In the event of a gas failure

WARNING

In the event of a gas failure, proper ventilation cannot be guaranteed. The Oxylog 3000 *plus* issues the alarm !!! *Supply pressure low.*

Disconnect the patient from the device and continue ventilation without delay using another ventilator.

In the event of an internal power supply failure

WARNING

In the event of an internal power supply failure, automatic ventilation, volume measurement and alarms do not operate.

An acoustic alarm signal is given to indicate the internal power supply failure.

Spontaneous breathing can continue through the emergency air intake.

Disconnect the patient from the device and continue ventilation without delay using another ventilator.

Setting alarm limits

CAUTION

Set alarm values carefully.

Extreme alarm values can render the alarm system useless.

Setting upper alarm limit for Paw

Regardless of the set ventilation mode, the airway pressure Paw is controlled by the ventilator and limited to the set maximum inspiratory pressure Pmax. The airway pressure is limited when Pmax is reached; inspiration will not be terminated prematurely. For more details refer to "Cardio-pulmonary resuscitation (CPR)" on page 67.

Pmax appears in the pressure curve as a dashed line. When this dashed line is reached, the Oxylog 3000 *plus* issues a **!!! Paw high** alarm.

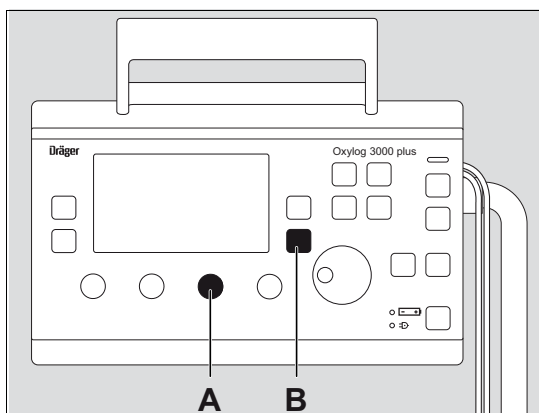

- 1 Set the maximum airway pressure Pmax via the **Pmax** control (A).

Lower alarm limit for Paw

The Oxylog 3000 *plus* automatically generates an alarm when it no longer detects a pressure difference of more than 5 mbar between the

inspiratory and expiratory pressure; for more than 20 seconds.

Setting alarm limits for MVe, RRsp and optional etCO2

WARNING

Set the lower alarm limit MVe ∇/\surd according to the minimum ventilation required for the patient.

Otherwise, there is a risk of the patient receiving insufficient ventilation.

- 1 Press the key **Alarms** $\triangleright\triangleright$ (B).

Display (example):

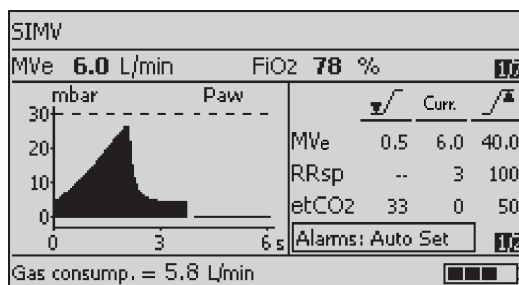

- 2 Select and activate the low alarm limit ∇/\surd or high alarm limit \surd/\blacktriangle for **MVe**, **RRsp** or **etCO2** on the display.
- 3 Set and confirm the value.

If the CO2 sensor cable is disconnected, etCO2 alarm limits are not visible.

If the CO2 sensor cable is disconnected and then reconnected, the previously set alarm limits will still be valid.

For the alarm limit ranges refer to "Alarm limit ranges" on page 141.

Setting alarm limits automatically

WARNING



After using the function **Alarms: Autoreset**, check if the new alarm limits are appropriate for the patient.



Risk of hypoventilation.

The function **Alarms: Autoreset** sets the alarm limits on the basis of the actual measured values at the time of activation. This automatic setting of alarm limits is performed only once, when confirmed with the rotary knob.

- 1 Press the key **Alarms**  (B).
- 2 Select and activate the line **Alarms: Autoreset** on the display.
- 3 Press the rotary knob to confirm **Alarms: Autoreset**, or press the **Alarm Reset** key to leave the settings unchanged.

The auto alarm limits are based on the actual measured values as follows:

Alarm	Setting
MVe 	Current value -20 %, with a minimum of 0.5 L/min. Below 0.5 L/min. the limit remains unchanged.
MVe 	Current value +30 % or +2 L/min, whichever is smaller
RRsp 	Current value +5/min, with a minimum of 10/min.
etCO ₂	Based on the current value

The etCO₂  /  auto alarm limits are based on the actual etCO₂ value as follows:

Lower alarm limit [mmHg]	Current measured value [mmHg]	Upper alarm limit [mmHg]
Unchanged	<15	Unchanged
Current -5	15 to 35	Current +15
Current -7	35 to 45	Current +10
Current -10	>45	Current +5

Lower alarm limit [kPA] or [Vol.%]	Current measured value [kPA] or [Vol.%]	Upper alarm limit [kPA] or [Vol.%]
Unchanged	<2.0	Unchanged
Current -0.7	2.0 to 4.7	Current +2.0
Current -0.9	4.7 to 6.0	Current +1.3
Current -1.3	>6.0	Current +0.7

Monitoring

Displaying curves	90
Displaying measured values	90
CO₂ measurement (optional)	91
Cuvette type setting	91
Checking the CO ₂ sensor during ventilation	91
Zero calibration during ventilation.	92
CO ₂ filter check during ventilation	93

Displaying curves

The curve window can display the airway pressure curve P_{aw} , the flow curve or the CO₂ curve (optional). Refer to "Screen window structure" on page 32.

To display a different curve:

- Press the **Curves**  key.

Displaying measured values

Measured values are displayed in the measured values window.

To switch between the values:

- Press the **Values**  key: the next value pair is displayed on the screen.

The following values can be displayed:

- MVe,
- FiO₂,
- RR,
- VTe,
- PEEP,
- Pmean,
- PIP,
- Pplat,
- MVespon,
- RRsp,
- etCO₂.

When the CO₂ sensor is connected to the ventilator, the etCO₂ value will be shown automatically in the measured values window.

The values are shown in pairs; the pairs of values can be configured as required. Refer to "Customer Service Mode" on page 98.

CO₂ measurement (optional)

The CO₂ measurement only works if the CO₂ option has been installed and if the CO₂ sensor is present.

- 1 Connect the CO₂ sensor and the cuvette (refer to "Connecting the CO₂ sensor and the cuvette" on page 48).
- 2 Set the cuvette type in the Settings menu (refer to Cuvette type setting).

The following will be activated:

- Curve window: CO₂ Curve
- Measured values window: the parameter etCO₂ will automatically be displayed
- Alarm window: etCO₂ high and etCO₂ low alarm

For more information on curves and measured values: refer to "CO₂ curve large view" on page 34.

For more information on configuring measured value pairs: refer to "Customer Service Mode" on page 98.

For connecting the CO₂ sensor and cuvette see page 48. For CO₂ zero calibration and filter check before ventilation, see page 58. For CO₂ configuration in the Customer Service Mode see page 105.

Cuvette type setting

NOTE

The cuvette windows of the reusable cuvette and disposable cuvette have different optical properties. Therefore, the correct cuvette type must be selected in the Setting menu. Otherwise the zero point is shifted by up to ± 8 mmHg of CO₂.

To set the cuvette type (reusable or disposable):

- 1 Press the **Settings**  key.
- 2 Select and activate the line **Cuvette type**.
- 3 Set the cuvette type and confirm.

NOTE

If a wrong cuvette type is selected, the Oxylog 3000 plus displays the alarm **!!! Check cuvette type**.

Checking the CO₂ sensor during ventilation

The following checks are necessary for the CO₂ sensor during ventilation:

Check	Interval
CO ₂ zero calibration	Recommended before measurement and when changing the CO ₂ sensor to another unit.
CO ₂ filter check	Required in intervals of one month.

Zero calibration during ventilation

The zero calibration is performed with a clean CO₂ sensor that has been removed from the cuvette!

NOTE

Do not breathe on the CO₂ sensor during zero calibration, otherwise the zero calibration can fail or the zero calibration can pass with an invalid zero value.

To perform zero calibration:

- 1 Connect the CO₂ sensor and wait at least 3 minutes for the CO₂ sensor to complete its warm-up phase.

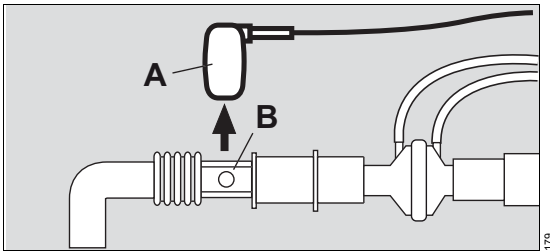

- 2 Remove the CO₂ sensor (A) from the cuvette (B).
- 3 Press the **Settings**  key.
- 4 Select and activate the line **CO₂ Zero Calib - Run**. The screen displays the text **Remove the sensor from cuvette then press rotary knob**.
- 5 Confirm. The zero calibration starts and the line displays **Busy**.
Note the possible warm-up time. During zero calibration, ventilation settings can be changed. After a successful zero calibration, the line briefly displays **Pass**.
- 6 Attach the CO₂ sensor (A) back to the cuvette (B).

If zero calibration was not successful:

The Oxylog 3000 *plus* displays the alarm **!!! CO₂ Zero calib. failed**.

- Repeat zero calibration.

If zero calibration is still not possible:

- 1 Check whether the sensor (A) is soiled and clean it if necessary. If the sensor is defective, replace the sensor.
- 2 Repeat zero calibration.

CO₂ filter check during ventilation

NOTE

Before the CO₂ filter check, you need to have finished a successful CO₂ zero calibration. Otherwise the CO₂ filter check may be outside of the tolerance range.

For connecting the CO₂ sensor and cuvette see page 48. For CO₂ zero calibration and filter check before ventilation, see page 58. For CO₂ configuration in the Customer Service Mode see page 105.

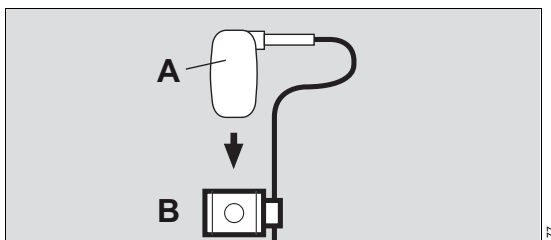

To perform CO₂ filter check:

- 1 Remove the CO₂ sensor from the cuvette.
- 2 Attach the CO₂ sensor (A) to the test filter (B).
- 3 Press the **Settings**  key.
- 4 Select and activate the line **CO₂ Filter check - Run**.
- 5 Confirm. The filter check starts and the line displays **Busy**.
During the filter check, ventilation settings can be changed.
After a successful filter check, the line briefly displays **Pass**.
- 6 Attach the CO₂ sensor (A) back to the cuvette.

If the check was not successful:

The Oxylog 3000 *plus* displays the alarm **!!! CO₂ Filter check failed**. The test value is outside the permissible tolerance.

- Check whether the sensor (A) or test filter (B) is soiled and clean them if necessary. Repeat the CO₂ filter check.

If the check was still not successful:

- Check the CO₂ calibration with test gas.

This page intentionally left blank

Configuration

Setting configuration parameters / display information	96
Displaying configuration and information .	97
Setting language	97
Displaying the battery type	97
Customer Service Mode	98
To enter Customer Service Mode	99
Settings in Customer Service Mode	99
To exit the parameter settings menu	99
Set start-up settings	100
Hose/cuvette start-up settings	101
Set date and time	102
Set the measured values display window	102
Enter activation code	102
Test buttons and potentiometer	102
Test loudspeaker, buzzer, LEDs and display .	103
Display battery and supply data	103
Check safety valve	104
Display info logbook entries	104
Display user logbook entries	104
Display maintenance and service contact information	104
CO2 sensor	105
Exit Customer Service Mode	109
Customer service manual	110

Setting configuration parameters / display information

The actual screen display may differ in appearance or configuration from these illustrations.

- 1 To switch the device ON briefly press the  key. The device performs a selftest and the operator is prompted, on the display, to activate the configuration menu or device check:
Press rotary knob for device check and configuration.
- 2 Press the rotary knob to confirm, before the black progress bar is complete.
The start-up menu is then displayed:

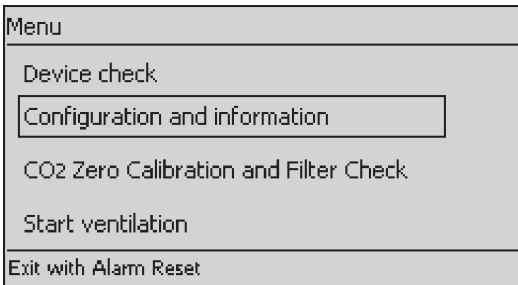

- 3 Select **Configuration and information** in the start-up menu and confirm.

Displaying configuration and information

- The settings made via the "Configuration" are retained after the ventilator is switched OFF.
- Configuration can be canceled by pressing the **Alarm reset** key.

The following data can be displayed via **Configuration and information**:

- Language
- Identification No. (Device ID)
- Total hours of operation (Working hours)
- Hours of operation since the last inspection and maintenance (Hours since service time)
- Battery type and battery capacity.

Setting language

- 1 Press the key **Settings**  to select the menu **Configuration**.
- 2 Select and activate the line **Language**.
- 3 Select the language and confirm.
The new language selected is effective immediately.

Configuration	
Language =	English
Device-ID:	8151127
Working hours [h]:	114
Hours since service-time [h]:	114
	
Continue with key adjustment / Exit with Alarm Reset	

08637171

Displaying the battery type

- Press the key **Settings**  to select the menu **Information**.
The performance data of the inserted battery are displayed on the device.

Information	
Batt. Manufact.:	EONEMOLI
Battery type:	LION ME202AH
Manufact. date:	2008-04
Batt. cycles:	9
Design Cap.:	6600 mAh
Act.capacity:	98 %
	
Continue with key adjustment / Exit with Alarm Reset	

screen 17

Customer Service Mode

NOTE

Ventilation is not possible when the device is in Customer Service Mode.

In Customer Service Mode, the ventilator performs function tests, outputs status information and permits configuration of parameter settings. Displays in Customer Service Mode appear in English and cannot be changed to any other language.

001	Set start-up settings.	Configure start-up settings, restore manufacturer's default settings.
002	Hose/cuvette start-up settings.	Determine which hose system / cuvette type is used.
003	Set date and time.	Set date and time.
004	Set measured values display window.	Configure the layout of measured values in the measured values window or restore manufacturer's default settings.
005	Enter activation code.	Enter the activation code for options.
006	Test buttons and potentiometer.	Check for correct functioning of keys and controls.
007	Test loudspeaker, buzzer, LEDs and display.	Check for correct functioning of loudspeaker, buzzer, LEDs and display.
008	Display battery and supply data.	Display battery data and condition of the supply voltage.
009	Check safety valve.	Checking of the safety valve.
010	Display info logbook.	Calibration logbook and technical errors in chronological sequence.
011	Display user logbook.	Logbook of operating phases, ventilator settings and alarms.
012	Display maintenance and service contact information.	Display the maintenance schedule and contact information for service personnel.
013	CO ₂ sensor.	Check or calibrate the CO ₂ sensor.

To enter Customer Service Mode

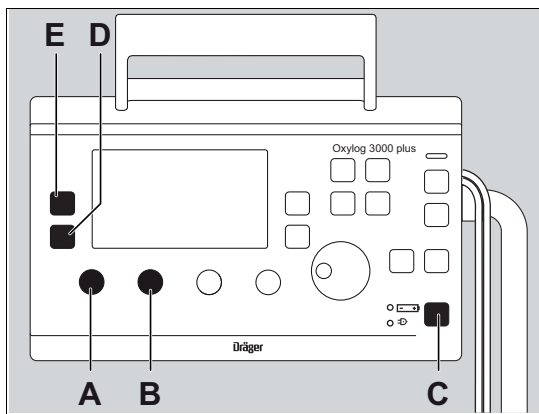

- 1 Ensure that ventilation is OFF.
- 2 Turn controls **VT** (A) and **RR** (B) all the way to the right.
- 3 Switch on the device by briefly pressing the Start/Standby key (C) and simultaneously press and hold the **Curves** (D) and the **Values** (E) key until the main **Customer Service Mode** menu appears.
- 4 In the main menu, set the number of the required test with the rotary knob.

```
Customer Service Mode
Testnumber :    1
Set startup settings

Switch OFF to quit servicemode
```

- 5 Press the rotary knob to activate the test.

Settings in Customer Service Mode

- 6 Select the required function with the cursor (asterisk).
 - To select a parameter: turn rotary knob.
 - To activate the parameter: press rotary knob.
 - To set a value: turn rotary knob.
 - To confirm the value: press rotary knob.

To exit the parameter settings menu

```
Set startup settings
Mode      = CMU
Tripper   = 0 lpm
PEMP      = 5 mbar
I:EMP/Ti  = 1:1.5
T:Plat%   = 1.0%
dP:SUPP   = 0 mbar
Slope     = STANDARD
P:IMP     = 20 mbar
O2-Flow   = - lpm

*Set factory default
*EXIT
```

Page 1/3

- 1 Select the line **EXIT**.
- 2 Press the rotary knob to confirm. The set values are saved as default settings and remain effective.

Set start-up settings

The ranges of the settings are:

Parameter	Range
Ventilation mode	
Trigger	0 (OFF) 1 to 15 L/min
PEEP	0 to 20 mbar
I:E or Ti	Configurable I:E or Ti
I:E	1:100 to 50:1
Ti	0.2 to 10.0 s
Tplat %	0 to 50 %
Δ Psupp	0 to 35 mbar
Slope	FLAT, MEDIUM, STEEP
Pinsp	3 to 55 mbar
O ₂ -Flow	0 to 15 L/min
NIV	ON, OFF
Tapn	0 (OFF) to 60 s
VTapn	50 to 2000 mL
RRapn	12 to 60 bpm
MVe-high alarm	2.0 to 41 L/min
MVe-low alarm	0.5 to 40 L/min
RR-high	10 to 100 bpm
HME correction	ON, OFF
AutoFlow	ON, OFF
Brightness-min*	1/4 to 4/4
Brightness	1/4 to 4/4
Alarm volume	1/4 to 4/4
etCO ₂ high alarm	1 to 100 mmHg
etCO ₂ low alarm	0 to 100 mmHg
CO ₂ unit	mmHg, kPa or Vol. %
Hose type	Adult disposable Adult reusable Paediatric disposable
Cuvette type	Disposable Reusable

The manufacturer's default settings are:

Parameter	Manufacturer's default setting
Ventilation mode	VC-CMV
Trigger	0 L/min at VC-CMV, VC-AC and 3 L/min at VC-SIMV, SpnCPAP, PC-BIPAP
PEEP	5 mbar
I:E or Ti	I:E
I:E	1.0:1.5
Ti	2.0 s
Tplat %	0 %
Δ Psupp	0 mbar
Slope (pressure rise time)	Standard
Pinsp	20 mbar
O ₂ -Flow	10 L/min
NIV	OFF
Tapn	0 s (when switched on minimum of 15 s)
VTapn	500 mL
RRapn	12 /min
MVe-high alarm	40.0 L/min
MVe-low alarm	0.5 L/min
RRsp-high alarm	100 /min
HME correction	OFF
AutoFlow	OFF
Brightness-min*	1/4
Brightness	3/4
Alarm volume	3/4
etCO ₂ high alarm	50 mmHg
etCO ₂ low alarm	33 mmHg
CO ₂ unit	mmHg
Hose type	Adult disposable
Cuvette type	Disposable

* Brightness-min: screen brightness level in power save mode. Refer to "Screen brightness" on page 81.

WARNING

A potential hazard may exist if different default alarm settings are configured for the same or similar equipment in any single area, e.g. an emergency department.

The user default settings for the parameters are displayed on the screen when the ventilator is switched ON. The settings can be adjusted.

```
Set startup settings
Mode      = CMV
Trigger  = 0 lpm
PEEP     = 5 mbar
I:E/Ti   = I:E
I:E      = 1.0:1.5
Tplat%  = 0 %
dPSUPP  = 0 mbar
Slope    = STANDARD
Pinsp   = 20 mbar
O2-Flow = 1 lpm

Set factory default
*EXIT                                     Page 1/3
```

Advance to the second page:

- 1 Select the line **Page**, confirm and turn rotary knob.

```
Set startup settings
NIU      = OFF
TApn    = 0 s
UTApn   = 500 ml
RRApn   = 12 bpm
MU-high = 40.0 lpm
MU-low  = 0.5 lpm
RR-high = 100 bpm
HME     = OFF
AutoFlow = OFF
Brightness-min = 1/4
Brightness = 3/4

Set factory default
*EXIT                                     *Page 2/3
```

To restore the manufacturer's defaults:

- 2 Select and confirm line **Set factory default**.

```
Set startup settings
Alarm volume = 3/4
etCO2-high  = 50 mmHg
etCO2-low   = 33 mmHg
CO2 unit    = mmHg

Set factory default
*EXIT                                     *Page 3/3
```

Hose/cuvette start-up settings

```
Hose/Cuvette startup settings

Ask for hose type = Yes

Hose type = Adult
            Disposable

Cuvette type = Disposable

Set factory default
*EXIT
```

- Ask for hose type = Yes: When switching on the device, prior to ventilation, the user is first asked to select the hose type.
- Ask for hose type = No: When switching on the device, it directly starts ventilating after the self-test, with the default hose type setting.
- Hose type: The start-up setting for the breathing hose (Adult Reusable, Adult Disposable or Paediatric Disposable).
- Cuvette type (optional): The start-up setting for the CO₂ cuvette type (Reusable or Disposable).

Set date and time

The date and time can be set.

```
Set date and time (GMT)
2008-11-10 14:33:13
Year
Month
Day
Hour
Minute
Set
*EXIT
```

10237170

- 1 Set the current date and time with the positions Year, Month, Day, Hour and Minute and confirm.
- 2 The date and time can be confirmed with »Set«.

Set the measured values display window

In the measured values window, six pairs of different values can be displayed. On the 7th page of the Settings window, an overview of all measured values will be displayed.

```
Set measured values display
| MVe          FiO2 | 1/6
| RR           RRsp | 2/6
| PEEP         Pmean | 3/6
| PIP          Pplat | 4/6
| MVesp        VTe   | 5/6
| etCO2       | 6/6
Set factory default
*EXIT
```

11637170

The arrangement of measured value pairs on the individual pages of the measured values window can be varied. etCO₂ is optional.

NOTE

It is recommended that you have the FiO₂ value as a displayed value during ventilation.

Each measured value can be freely selected in any position and is only displayed at that position.

To define the eleven values to be displayed:

- Start configuration on page 1/6 and continue through to 6/6.

Enter activation code

```
Enter activation code
Device-ID: 8847360
Activated: CO2
          Dat Export
          100% O2
          Autoflow
New code : 0000000000
Set
*EXIT
```

11437170

The activation codes for options can be entered. The activated options are then displayed. For the possible options, refer to "List of Accessories" on page 167.

Test buttons and potentiometer

```
Test buttons and Potentiometer
Press (B)uttons, adjust potis
=====
##### B B B
B # Display # B B B B
B # ##### B B B
UT RR Pmax O2
2000 60 60 40
[ml] [bpm] [mbar] [%] B
=====
*EXIT
```

09437170

The operating elements on the front panel are displayed schematically on the screen.

- Display = screen
- B = buttons

Set the controls accordingly for the test:

- **VT** to 500 mL
- **RR** to 20/min
- **Pmax** to 40 mbar
- **FiO2** to 40 %

These settings are displayed on the screen.

To test the buttons:

- 1 Briefly press the corresponding button.
The associated letter on the screen changes from "B" to "X". If the button has an indicator, it will be illuminated by the device. If there are buttons without an indicator, the yellow warning indicator will light up on the device.

NOTE

If you press the  key for longer than 3 seconds, the ventilator switches OFF.

The function of the rotary knob is not included in the test.

Test loudspeaker, buzzer, LEDs and display

To test the loudspeaker, buzzer, all LEDs and the display:

- 1 Select the required test.

```
Test loudspeaker, buzzer, LEDs
and display
Test loudspeaker: !!! WARNING
Test loudspeaker: !! CAUTION
Test loudspeaker: ! ADVISORY
Loudness = 3/4

Test buzzer
Test LEDs

Test display
Brightness min = 1/4
Brightness max = 3/4
*EXIT
```

- 2 Confirm the test with the rotary knob. The requested function is tested by the device.

To test the screen display (Test display).

- 3 Turn the rotary knob; various test cards are displayed.

The selected test remains active until the rotary knob is pressed again.

Display battery and supply data

The parameters of the replaceable battery and the status of the external power supply are displayed. Display (example):

```
Display Bat. and supply data
Charger          : U01.22
*EXIT SUPPLY    : OK
battery status   : +
battery type     : NiMH
bat. manufact.   : ZAH
bat. serialnr.   : MOL I
bat. chemistry   : LIION
battery date     : 08-06-17
battery cycle    :
bat. desigtemp.  :
bat. desigcap.   : 1500 mAh
bat. fullcap     : 1500 mAh
*EXIT                               Page 1/2
```

Advance to the second page:

- Select the line **Page**, confirm and turn rotary knob.

Display (example):

```
Display Bat. and supply data
Battery actualcap: 100 %
Battery voltage   : 12.5 V
Battery current   : 0.0 mA
Charger voltage   : 0.0 V
Charger current   : 0 mA
EXIT                               *Page 2/2
```

Check safety valve

```

Check safety valve

  Close gas-outlet !

*Generate 20.0 lpm flow

  Pint:  0.0 mbar

EXIT
    
```

15037171

For safety inspection, a flow can be generated to test the safety valve.

Display info logbook entries

Any technical errors and/or special occurrences, such as activation of a software option, completion of the device check and device calibration, are listed in chronological sequence.

Display (example):

```

Display info logbook entries
I 2008.08.07 16:54:41
SOFTWARE: Modul line
I 2008.08.07 16:54:41
Service mode entry
I 2008.08.07 16:54:41
CALIB: Device not calibrated
I 2008.08.07 16:54:41
MAINBOARD: LSspeaker unplugged
*EXIT                               Page 001/003
    
```

06637171

Advance to the next page:

- Select line **Page**, confirm and turn the rotary knob.

Display user logbook entries

```

Display user logbook entries
Z 2008.08.07 16:54:41
O Fi O2 0-> 40
Z 2008.08.07 16:54:41
O Pmax (0.1bpm) 0-> 600
Z 2008.08.07 16:54:41
O Frea (0.1bpm) 0-> 600
Z 2008.08.07 16:54:41
O UT (ml) 0-> 2000
*EXIT                               Page 001/025
    
```

11237170

The operating phases with ventilator settings and time are listed in chronological sequence.

Advance to the next page:

- Select line **Page**, confirm and turn the rotary knob.

Display maintenance and service contact information

```

Display maintenance and
service contact information

Maintenance:
Next service:
Last service:

Service contact information:
Name:
Phone:

*EXIT
    
```

10137170

The maintenance schedule and contact information for service personnel are displayed. The message **Service date overdue !** is shown if service is needed.

CO₂ sensor

```

CO2 sensor

Zero Calibration
*Filter/gas check
Gas Calibration
EXIT
  
```

Prerequisite: The CO₂ option is activated. The following actions can be selected:

- Zero Calibration;
- Filter/gas check;
 - Filter check;
 - Gas check;
- Gas Calibration;
 - Start gas calibration;
 - Reset to factory default;

Performing zero calibration

NOTE

Do not breathe on the CO₂ sensor during zero calibration, otherwise the zero calibration can fail or the zero calibration can pass with an invalid zero value.

Start zero calibration:

- 1 Connect the CO₂ sensor to the ventilator. Wait at least 3 minutes for the CO₂ sensor to complete its warm-up phase.
- 2 Remove the CO₂ sensor (A) from the cuvette (B).

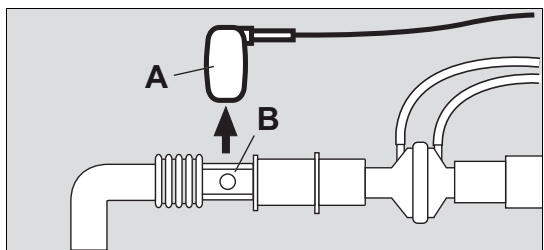

- 3 Open page **CO₂ sensor**, select the line **Zero calibration** and confirm. The screen displays the text **Remove sensor from cuvette**.
- 4 Confirm with rotary knob. The Oxylog 3000 *plus* performs the zero calibration and displays the message **Zero calibration in progress**.

If zero calibration was successful:

After approx. 5 seconds the Oxylog 3000 *plus* confirms with the message **Zero calibration successful**.

If zero calibration was not successful:

The Oxylog 3000 *plus* displays the alarm **Zero calibration failed**.

- Repeat zero calibration.

If zero calibration is still not possible:

- 1 Check whether the sensor (A) is soiled and clean it if necessary. If the sensor is defective, replace the sensor.
- 2 Repeat zero calibration.

Start the calibration of the CO₂ sensor with a test filter

NOTE

Before the calibration check with a test filter, perform CO₂ zero calibration. Otherwise the check with the test filter may be incorrect.

Start calibration check with a test filter:

- 1 Open page **CO₂ sensor**, select the line **Filter/gas check** and then the line **Filter check** and confirm. The screen displays the text **Place sensor on test filter**.
- 2 Remove the CO₂ sensor from the cuvette and attach the CO₂ sensor (A) to the test filter (B) of the sensor cable.

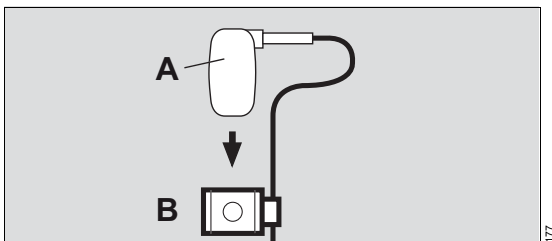

- 3 Confirm with the rotary knob. The Oxylog 3000 *plus* performs the filter test and displays the message **Filter check in progress**.

If the check was successful:

The Oxylog 3000 *plus* displays the message **Filter check successful**. The test value is inside the permissible tolerance.

If the check was not successful:

The Oxylog 3000 *plus* displays the alarm **Filter check failed**. The test value is outside the permissible tolerance.

- Check whether the sensor (A) or test filter (B) is soiled and clean them if necessary. Repeat the CO₂ filter check.

If the check was still not successful:

- Check the CO₂ calibration with test gas.

Start the gas check of the CO₂ sensor with test gas

Carry out the check when the test values are not met during the calibration check of the CO₂ sensor with a test filter.

NOTE

The gas check with test gas must only be carried out after zero calibration has been performed. Otherwise the gas check with test gas may be incorrect.

NOTE

For the check and calibration only use a test gas which consists of CO₂ and N₂.

Otherwise display deviations of ± 0.5 % by volume CO₂ may occur.

- 1 Use the reusable cuvette from the calibration set.

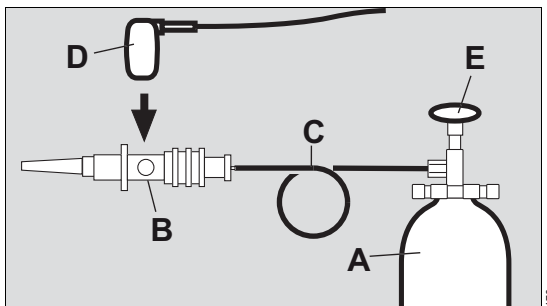

- 2 Connect the test gas cylinder (A) and the cuvette (B) of the calibration set to the hose (C).

- 3 Fit the CO₂ sensor (D) on the cuvette (B) of the calibration set and connect the CO₂ sensor to the ventilator.
- 4 Open the page **CO₂ sensor**, select the line **Filter/gas check** and then the line **Gas check** and confirm. The display now shows **Turn on testgas**.
- 5 Read the CO₂ concentration of the test gas from the test gas cylinder (A).
- 6 Open the test gas cylinder (E) and set the test gas flow to 0.1 L/min. Select **CONTINUE** and confirm with the rotary knob.
- 7 The Oxylog 3000 *plus* displays the CO₂ concentration **Measured CO₂ value**.
- 8 About 1 minute after the test gas flow has been set, the value of CO₂ must match (within $\pm 0.2\%$ by volume) to the CO₂ content of the test gas read from the test gas cylinder.
- 9 Close the test gas cylinder.

If the test value is outside the permitted tolerance, the CO₂ sensor must be recalibrated with test gas.

Start the calibration of the CO₂ sensor

The CO₂ sensor must be calibrated if the test values are not met during the calibration check with test gas.

NOTE

The calibration with test gas must only be carried out after zero calibration has been performed. Otherwise the calibration with test gas may be incorrect.

NOTE

For the calibration only use a test gas which consists of CO₂ and N₂.

Otherwise display deviations of $\pm 0.5\%$ by volume CO₂ may occur.

- 1 Use the reusable cuvette from the calibration set.

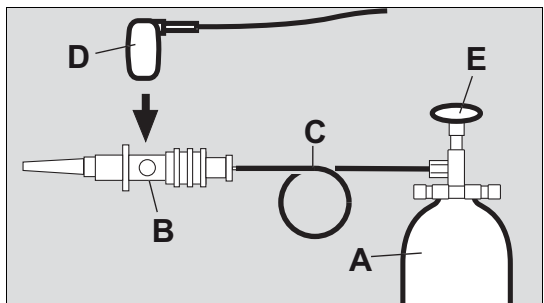

- 2 Connect the test gas cylinder (A) and the cuvette (B) of the calibration set to the hose (C).
- 3 Fit the CO₂ sensor (D) on the cuvette (B) of the calibration set, and connect the CO₂ sensor to the ventilator.
- 4 Open the page **CO₂ sensor**, select the line **Gas calibration** and then **Start gas calibration** and confirm.
- 5 Enter the CO₂ test gas concentration in the line **Set gas conc.** with the rotary knob and confirm. This value can be found on the test gas cylinder (A).
- 6 Select the line **Start gas calibration** and confirm with the rotary knob. The display now shows **Turn on test gas**.
- 7 Open the test gas cylinder (E) and set the test gas flow to 0.1 L/min.
- 8 About 1 minute after setting this test gas flow, select **CONTINUE** and confirm with the rotary knob.
- 9 The Oxylog 3000 *plus* starts the calibration of the CO₂ sensor and displays the progress and result of the calibration in the message field.
- 10 Close the test gas cylinder.

If calibration was successful:

The Oxylog 3000 *plus* displays the message **Calibration successful**.

If calibration was not successful:

The Oxylog 3000 *plus* displays the message **Calibration failed**.

If calibration failed, the following causes are possible:

Cause	Remedy
The entered CO ₂ concentration does not match the value on the test gas cylinder.	Check the entered CO ₂ concentration.
The test gas cylinder is empty.	Use a new test gas cylinder.
The CO ₂ sensor is defective.	Change the CO ₂ sensor.

- Repeat the calibration of the CO₂ sensor.

Resetting the calibration of the CO₂ sensor

If problems occurred during calibration, the sensor can be reset to the factory default values.

- Open page **CO₂ sensor**, select the line **Gas calibration** and then the line **Reset to factory default** and confirm.

The factory-set calibration value is effective again after approx. 5 seconds.

- Perform correct calibration of the CO₂ sensor as soon as possible.

If the calibration was unsuccessful, the previously valid calibration remains effective.

For connecting the CO₂ sensor and cuvette see page 48. For CO₂ zero calibration and filter check before ventilation, see page 58. For CO₂ zero calibration and filter check during ventilation, see page 91. For CO₂ measurement see page 91.

Exit Customer Service Mode

- 1 Press the key  for approximately 3 seconds; the indicator flashes yellow.

To turn ventilation on:

- 2 Briefly press the key .

To switch off:

- 3 Press the rotary knob.

Customer service manual

Should you need additional information on the Oxylog 3000 *plus*, refer to Customer service manual (can be ordered through DrägerService).

Problem Solving

Alarm - Cause - Remedy	112
Messages in the alarm window	112
Messages in the information window	120
Error messages during the device check	122

Alarm - Cause - Remedy

The Oxylog 3000 *plus* classifies alarm messages according to three priority levels and identifies these accordingly with the aid of exclamation marks:

!!!	Warning	High-priority alarm message
!!	Caution	Medium-priority alarm message
!	Advisory	Low-priority alarm message

In the following table, the alarm messages are listed in alphabetical order. If an alarm occurs, the table helps to identify causes and remedies. The different causes and remedies should be worked through in the order listed until the cause of the alarm has been resolved.

When multiple alarms occur, they are displayed according to their Alarm Rank, as illustrated in the table below. A lower number has a higher rank.

Messages in the alarm window

Alarm	Cause	Remedy	Alarm Rank
!!! Apnoea	Spontaneous breathing by the patient has failed, or disconnection. <hr/> Faulty flow sensor.	Check patient condition. Ventilate in VC-CMV mode. Ensure that hose connections are tight. <hr/> Replace flow sensor.	9
!!! Apnoea ventilation (only for CPAP)	The ventilator has automatically switched over to mandatory ventilation after detecting an apnoea (only in SpnCPAP mode).	Check patient condition. Check ventilation settings. To return to the original ventilation mode: Press the Alarm Reset key.	8
!! Charge int. battery	The Oxylog 3000 <i>plus</i> draws its power from the internal battery due to the absence of an external power supply. There are only approximately 10 minutes of operating time remaining in the internal battery.	The ventilator must immediately be reconnected to the mains power supply or an onboard power supply, or a fully charged battery must be installed (ventilation stops while installing the battery).	29
!!! Check cuvette type	An incorrect cuvette type is selected. <hr/> Cuvette or sensor soiled.	Select the correct cuvette type. <hr/> Clean the cuvette or sensor.	18

Alarm	Cause	Remedy	Alarm Rank	
	Zero point of the CO ₂ sensor is outside the tolerance range.	Perform the zero calibration.		
	Inspiratory CO ₂ concentration high.	Check patient status and ventilation.		
!!!	Check measuring lines	The flow measuring lines are connected incorrectly.	Connect the flow measuring lines correctly.	10
!!	Check settings: flow	The flow resulting from the settings for "Tidal volume VT per unit time" is not possible.	Change tidal volume VT or inspiratory time Ti or ventilation time ratio I:E , plateau time Tplat% , or respiratory rate RR .	26
!	Check settings FiO₂	The set FiO ₂ concentration cannot be achieved with the set flow.	Adjust inspiratory flow or FiO ₂ concentration (in accordance with measured value).	40
!!	Check settings: time	The inspiratory and / or expiratory time resulting from the settings for RR and I:E or Ti are not possible.	Change RR or I:E or Ti .	25
!!	CO₂ Filter check failed	The sensor reports a filter check failure.	Perform the zero calibration. Do not breathe on the CO ₂ sensor during calibration. Clean the CO ₂ test filter or the CO ₂ sensor and cuvette windows. Check the CO ₂ calibration with test gas.	20
!!	CO₂ sensor?	The connector of the CO ₂ sensor was removed during operation.	Reinsert the connector.	16
		The CO ₂ sensor has a hardware failure.	Replace the CO ₂ sensor.	
!!	Clean the CO₂ cuvette	The sensor or cuvette window is soiled.	Clean the sensor and cuvette windows. Perform the zero calibration.	17

Alarm	Cause	Remedy	Alarm Rank
!! CO₂ Zero calib. failed	Zero calibration of the CO ₂ sensor failed.	Do not breathe on the CO ₂ sensor during calibration. Redo the zero calibration.	19
	The sensor window is soiled.	Clean the CO ₂ sensor window.	
	The CO ₂ sensor has a hardware failure.	Replace the CO ₂ sensor.	
!!! CO₂ Zero calib. request	Zero point of the CO ₂ sensor is outside the tolerance range.	Perform the zero calibration.	21
! Confirm settings	Changed setting has not been confirmed with the rotary knob.	Press the rotary knob to confirm the setting change.	41
!!! Continuous high pressure	Breathing valve or hose system obstructed.	Check patient condition. Check breathing valve and hose system.	5
	Increased expiratory resistance.	Check bacterial/HME filter. Replace it if necessary.	
	Technical defect.	Disconnect the patient from the device and continue ventilation without delay using another ventilator. Call DrägerService.	
!!! Device failure	Technical defect.	Disconnect the patient from the device and continue ventilation without delay using another ventilator. After pressing Alarm Reset the device will directly display further failure information in the Customer Service Menu. Call DrägerService.	1
!!! Display inop	Technical defect.	Disconnect the patient from the device and continue ventilation without delay using another ventilator. Call DrägerService.	36
!! etCO₂ high	The upper alarm limit for end-expiratory CO ₂ concentration has been exceeded.	Check patient condition.	22
		Check alarm limits	
		Adjust the alarm limit, if necessary.	

Alarm	Cause	Remedy	Alarm Rank
!! etCO₂ low	The lower alarm limit for end-expiratory CO ₂ concentration has been exceeded.	Check patient condition. Check alarm limits Adjust the alarm limit, if necessary.	23
!! Flow measurement inop	Measurement lines for flow measurement kinked, disconnected or leaking. Flow sensor defective. Technical defect.	Ensure that the flow measuring lines are connected correctly. Replace flow sensor. Disconnect the patient from the device and continue ventilation without delay using another ventilator. Call DrägerService.	35
!! High respiratory rate	Patient breathes at a high spontaneous rate.	Check patient condition, check ventilation pattern, correct alarm limit RRsp if necessary.	27
!! Int. battery charging inop	The internal battery is not being charged due to a battery failure. The internal battery is not being charged due to a device failure.	Exchange internal battery. Call DrägerService. Continuous ventilation with this device is only possible with an external power source. Call DrägerService.	30
!!! Int. battery discharged	The operating time for operation with the internal battery has expired and an external power supply has not been connected.	The ventilator must immediately be reconnected to a mains power supply, an on-board DC supply or a fully charged battery must be installed.	2
!! Int. battery in use	During ventilation, when the external power source has been disconnected, the internal battery becomes the main power source. When starting ventilation while using the internal battery this alarm will not be issued.	Connect an external power supply. Press the Alarm Reset key to confirm the alarm.	24

Alarm	Cause	Remedy	Alarm Rank
!! Key failed	A key is pressed for longer than 30 seconds.	Press keys only briefly.	31
	Technical defect.	To continue ventilation with this device, verify the ventilation settings and continuously monitor the device functions. Call DrägerService.	
!!! Leakage (not in NIV)	The measured expiratory tidal volume VT is approximately 40 % lower than the inspiratory value.	Repair leakages in hose system and / or patient connection. Use a new hose system.	15
	Faulty flow sensor.	Replace the flow sensor.	
	Technical defect.	Disconnect the patient from the device and continue ventilation without delay using another ventilator. Call DrägerService.	
!! Loss of data	No logbook data or clock available. Actual settings will be lost in case of a power loss.	Ventilation functions are not affected. Call DrägerService.	33
!! Loudspeaker inop	Technical defect.	To continue ventilation with this device, continuously monitor the device functions. Call DrägerService.	34
!!! MVe high	The upper alarm limit for the minute volume MVe has been exceeded.	Check patient's condition, check ventilation pattern, adjust alarm limits if necessary.	14
	Faulty flow sensor.	Replace flow sensor.	
	Technical defect.	Disconnect the patient from the device and continue ventilation without delay using another ventilator. Call DrägerService.	

Alarm	Cause	Remedy	Alarm Rank
!!! MVe low	The minute volume MVe has dropped below its lower alarm limit.	Check patient's condition, check ventilation pattern, adjust alarm limits if necessary.	13
	Leakage in exhalation system.	Ensure connections in exhalation system are tight.	
	Faulty flow sensor.	Replace flow sensor.	
	Technical defect.	Disconnect the patient from the device and continue ventilation without delay using another ventilator. Call DrägerService.	
!! No int. battery ?	Internal battery not installed, faulty or wrong battery installed.	Fit battery or press the Alarm Reset key to confirm the alarm or change internal battery.	37
! No int. battery ?	Internal battery not installed, faulty or wrong battery installed.	Advisory message, is displayed continuously when confirmed. Fit battery or change internal battery.	38
! No int. battery charging	Internal battery cannot be charged due to a faulty battery or too hot or cold environment.	Press the Alarm Reset key to confirm the alarm. Change internal battery.	39
!! Only 100 % O₂ to patient	Technical defect.	Independent of the set FiO₂ , the device supplies 100 % O ₂ to the patient. Other ventilation functions remain unchanged. Call DrägerService.	32
!!! Paw high	The alarm limit Pmax for the airway pressure has been reached. Patient "fights" the ventilator, coughing.	Check patient's condition, check ventilation pattern, adjust alarm limits if necessary.	4
	Breathing hose kinked, or obstructed.	Check hose system, breathing valve and tube.	

Alarm	Cause	Remedy	Alarm Rank
!!! Paw low	The set pressure level is not achieved or no pressure difference >5 mbar between inspiration and expiration. Leakage in cuff.	Inflate cuff and check for leak-ages.	7
	Leakage or disconnection.	Check hose system for leaking connections. Ensure that the breathing valve has been installed correctly.	
!!! Paw measurement inop	Fault in flow measuring lines.	Check hose system for loose connections. Ensure flow measuring lines are connected correctly.	6
	Technical defect.	Disconnect the patient from the device and continue ventilation without delay using another ventilator. Call DrägerService.	
!!! Reselect hose type	The detected hose type is not the same as the selected hose type.	Change hose type setting.	11
	Flow sensor defective	Connect a different hose type. Replace flow sensor	
! Self test OK	The device has been switched on and the selftest completed successfully.	The message disappears automatically after approximately 15 seconds.	44
! Settings not confirmed	Changed setting has not been confirmed with the rotary knob.	Redo the setting change.	43
!!! Supply pressure low	Supply pressure <1800 mbar.	Ensure that supply pressure exceeds 1800 mbar. Disconnect the patient from the device and continue ventilation without delay using another ventilator.	3
!! VT high for hose	The measured VT is above 250 mL, while using a paediatric hose.	Set a lower VT or press the Alarm Reset key to confirm the alarm.	12
	An incorrect hose connected.	Use another hose or press the Alarm Reset key to confirm the alarm.	

Alarm	Cause	Remedy	Alarm Rank
! VT high for hose	The measured VT is above 250 mL, while using a paediatric hose.	Advisory message, is displayed continuously when confirmed. Set a lower VT.	42
	An incorrect hose connected.	Advisory message, is displayed continuously when confirmed. Use another hose.	
!! VT low, pressure limit	During AutoFlow additional pressure is necessary to achieve the set tidal volume VT . (Pressure is limited to Pmax - 5 mbar.)	Check patient condition. Check ventilation settings	28

Messages in the information window

The numeric values below are examples.

Message	Unit ¹⁾	Cause	Explanation/Remedy
Confirm PEEP above 10 mbar ?		PEEP >10 mbar has been set but not confirmed.	The required setting of PEEP >10 mbar is only possible when confirmed via the rotary knob.
Gas consumption = 10 L/min		Standard display in information window for the current gas consumption.	
 (Battery capacity)		Standard display in information window for the current battery capacity.	
REUS = Adult reusable hose DISP = Adult disposable hose PAED = Paediatric disposable hose		Explanation of abbreviation, when selecting the hose type in the Settings window.	
Select and confirm connected hose with rotary knob.		Confirm hose type.	Select and confirm.
REUS = Reusable Cuvette DISP = Disposable Cuvette		Explanation of abbreviation, when selecting the cuvette type in the Settings window.	
Press Rotary Knob for Autose / Exit with Alarm Reset		Activation of Alarms: Autose , refer to "Setting alarm limits" on page 87.	After pressing the rotary knob the new alarm limits will be set.
Remove sensor from cuvette then press Rotary Knob		Activation of CO₂ zero calibration , refer to "CO ₂ measurement (optional)" on page 91.	After removal of the CO ₂ sensor from the cuvette and pressing the rotary knob, the zero calibration will proceed. Cancel by pressing Alarm Reset .
Place sensor on reference filter then press Rotary Knob		Activation of CO₂ filter check , refer to "CO ₂ measurement (optional)" on page 91.	After mounting the test filter and pressing the rotary knob, the filter check will proceed. Cancel by pressing Alarm Reset .
Pinsp>=PEEP + 3 mbar		Set PEEP + 3 mbar > Pinsp	Set Pinsp > PEEP + 3 mbar

Message	Unit ¹⁾	Cause	Explanation/Remedy
Psupp = 22 mbar		Change in ΔP_{supp} or PEEP.	Psupp is the absolute pressure resulting from PEEP + ΔP_{supp} .
VT = 400 mL or RR = 12 /min Ti= 1.5 s Flow = 15 L/min	I:E	Change in VT or RR, in ventilation mode VC-CMV, VC-AC or VC-SIMV.	
VT = 400 mL or RR = 12 /min I:E= 1 : 1.5 Flow = 15 L/min	Ti		
RR = 12 /min Ti= 1.5 s Te = 9.5 s	I:E	Change in RR, in ventilation mode PC-BIPAP.	
RR = 12 /min I:E= 1 : 1.5 Te = 9.5 s	Ti		
Ti= 1.5 s Flow = 15 L/min	I:E	Change in I:E, Ti or Tplat %, in ventilation mode VC-CMV, VC-AC or VC-SIMV. Or change in RRapn or VT, in ventilation mode SpnCPAP.	
I:E= 1.5 : 1 Flow = 15 L/min	Ti		
Ti= 1.5 s Te= 9.5 s	I:E	Change in I:E or Ti, in ventilation mode PC-BIPAP.	
I:E= 1 : 1.5 Te= 9.5 s	Ti		

1) Unit I:E or Ti is configurable. Refer to "Customer Service Mode" on page 98.

Error messages during the device check

Message	Cause	Explanation/Remedy
System leakage	Leakage in breathing circuit and/or test lung.	Check hoses, breathing valve, flow sensor and test lung for leakages and replace if necessary.
	Internal leakage in system	Contact your local DrägerService for additional support.
No test lung	Test lung not connected or major leakage	Connect test lung. Check hoses, breathing valve, flow sensor and test lung for leakages and replace if necessary.
	Breathing valve has malfunctioned.	Check correct condition of breathing valve including diaphragm and rubber disc; fit a new breathing valve if necessary or use a new disposable hose set.
Pressure measurement inop	The breathing circuit has not been connected correctly.	Connect ventilation system correctly.
	Pressure measurement is not possible.	Contact your local DrägerService for additional support.
PEEP-valve inop	Internal leakage in system	Check hoses, breathing valve, flow sensor and test lung for leakages and replace if necessary.
	Device defective	Contact your local DrägerService for additional support.
Patient flow measurement inop	Flow measurement implausible	Replace flow sensor. Contact your local DrägerService for additional support.
Hose Detection inop	The device check failed on the hose detection.	Connect a different hose or change hose type setting.
Detected hose differs from selected hose	The hose that is detected differs from the selected hose type, or flow measuring lines incorrectly positioned.	Connect a different hose or change hose type setting.
Check measuring lines	The flow measuring lines are connected incorrectly.	Connect the flow measuring lines correctly.

Cleaning, Disinfection and Sterilization

Disassembly	124
Remove the CO ₂ sensor and cuvette	124
Disassemble the adult reusable hose system	124
Removal of the adult disposable hose system	126
Removal of the paediatric disposable hose system	126
Safety Information on reprocessing	127
Reprocessing procedure	127
Classification of medical products	127
Testing of procedures and agents	127
Uncritical medical products	128
Semicritical medical products	128
Visual inspection	130
Sterilization	130
Reprocessing list	131
Assembling parts	131

Disassembly

Remove the CO2 sensor and cuvette

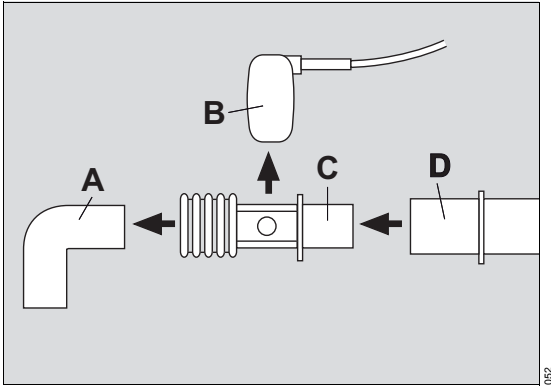

- 1 Unplug the CO2 sensor connector at the side of the Oxylog 3000 *plus*.
- 2 Remove the CO2 sensor (B) from the CO2 cuvette (C).
- 3 Remove the CO2 cuvette (C) from the flow sensor (D).
- 4 Remove the angled connector (A) from the cuvette (C).

Disassemble the adult reusable hose system

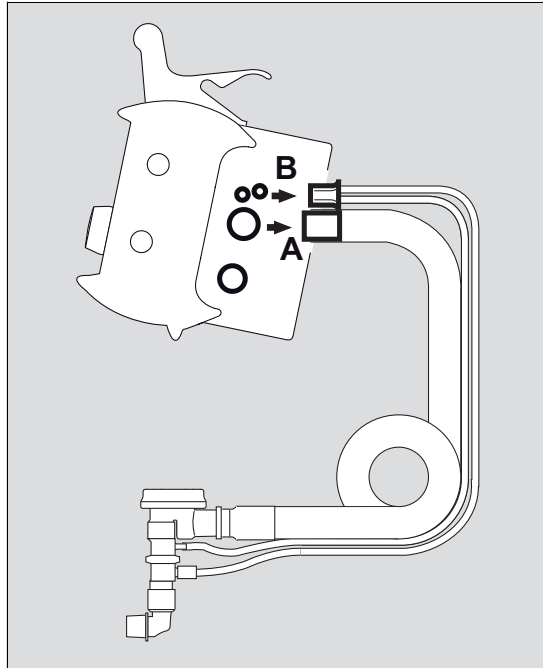

- 1 Disconnect the breathing hose (A) from the gas output.
- 2 Disconnect the flow measuring lines (B) from the nozzles.

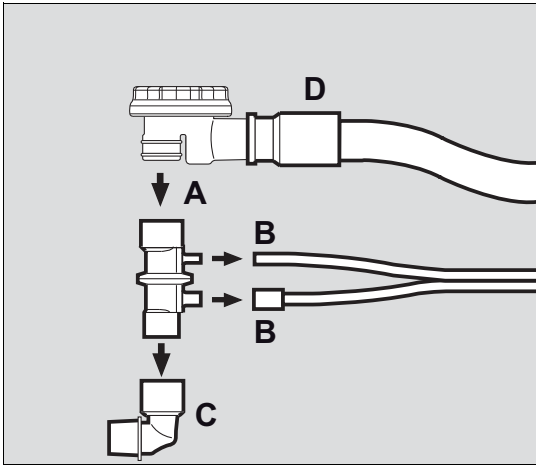

- 3 Disconnect the flow sensor (A) from the breathing valve.
- 4 Carefully detach the flow measuring lines (B) from the flow sensor. Pull the hoses straight off the connections.

CAUTION

Do not twist or use force when disconnecting the flow measuring lines from the flow sensor nozzles.

This can damage the flow sensor.

- 5 Detach the angled connector (C) from the flow sensor.
- 6 Detach the breathing hose (D) from the breathing valve.

Breathing valve, disassembly

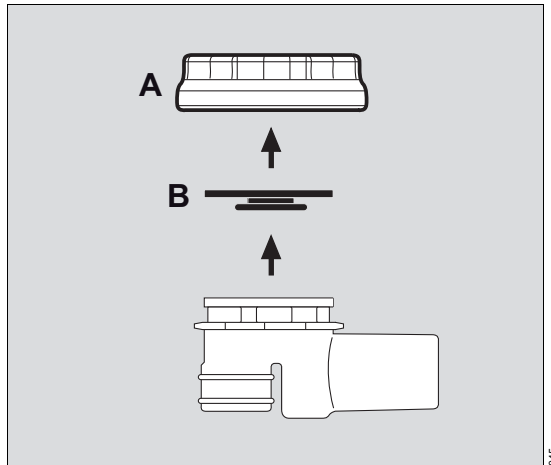

- 7 Turn the cover (A) about 90° counterclockwise to unlock the cover.
- 8 Remove the silicone diaphragm (B).

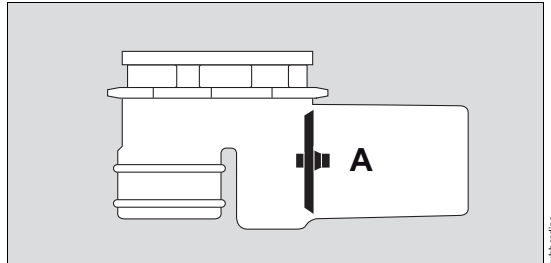

WARNING

The rubber disc (A) in the housing must not be removed, damaged or bent, otherwise the valve will not work properly and endangers the patient.

Risk of CO₂ rebreathing.

Removal of the adult disposable hose system

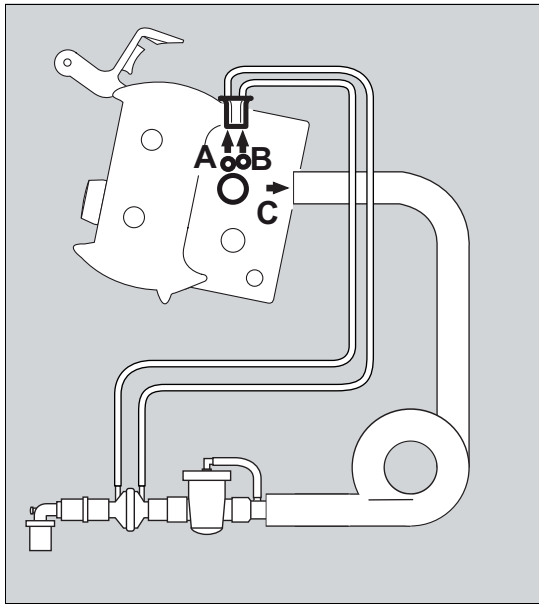

- 1 Disconnect flow measuring lines (A and B).
- 2 Disconnect the breathing hose (C).
- 3 Correctly dispose of the complete disposable hose system. Refer to the chapter "Disposal" on page 137.

CAUTION

The disposable hose system must not be cleaned, disinfected or sterilized: it cannot withstand high temperatures and may be damaged.

Removal of the paediatric disposable hose system

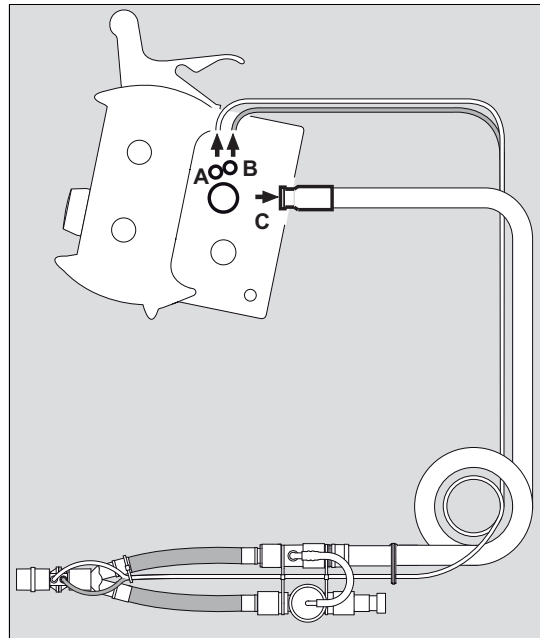

- 1 Disconnect flow measuring lines (A and B).
- 2 Disconnect the breathing hose (C).
- 3 Correctly dispose of the complete paediatric hose system. Refer to the chapter "Disposal" on page 137.

CAUTION

The disposable paediatric hose system must not be cleaned, disinfected or sterilized: it cannot withstand high temperatures and may be damaged.

Safety Information on reprocessing

CAUTION

To reduce the risk of infection to both hospital staff and patients, the device must be cleaned and disinfected whenever it has been used.

Protective clothing, eye protection etc. must be worn.

- Observe the hospital hygiene regulations.
- Reprocess the device after every patient.

The reprocessing recommendations do not exempt staff from the obligation to adhere to the hygiene requirements and directives on occupational health and safety relating to the reprocessing of medical devices.

To ensure the professional reprocessing of medical devices, the recommendations provided by the Robert Koch Institute in "Demands on Hygiene in Reconditioning Medical Products" must be followed.

WARNING

Single-use articles have been developed, tested and manufactured for single use only. Single-use articles must not be reused, reprocessed or sterilized. Reuse, reprocessing or sterilization can lead to a failure of the accessories and cause injuries to the patient.

Reprocessing procedure

For the reprocessing list, refer to section "Reprocessing list" on page 131.

Classification of medical products

For reprocessing, the medical products and components are classified by their way of application and the risk resulting from it:

- Uncritical medical products: Surfaces accessible to the user, e.g. device surfaces, cables
- Semicritical medical products: Parts conducting breathing gas, e.g. breathing hoses, masks

Referring to its reprocessing, this medical product belongs to the group of uncritical medical products.

Testing of procedures and agents

The cleaning and disinfection of medical products has been tested with the following procedures and agents. The following agents showed good material compatibility and effectiveness at the time of the test:

Manual cleaning:

- For device surfaces:
Neoform MED AF by Dr. Weigert
(Concentration 2%)
- For the breathing valve and hoses:
Neodisher LM2 by Dr. Weigert
(Concentration 2%)
- For the flow sensor:
Sekusept Powder classic by Ecolab
(Concentration 4%)

Manual disinfection:

- Korsolex extra by Bode Chemie (Concentration 3%)

Machine cleaning and disinfection:

- Neodisher MediClean by Dr. Weigert (for thermal disinfection at 93°C for 10 minutes)

Uncritical medical products

Manual cleaning and disinfection

Manual disinfection should preferably be carried out with disinfectants based on aldehydes or quaternary ammonia compounds.

Observe the applicable country-specific listings for disinfectants. The list of the German Association for Applied Hygiene (Verbund für Angewandte Hygiene VAH) applies in German-speaking countries.

The composition of the disinfectant is the responsibility of the manufacturer and can change over time.

Strictly observe the manufacturer's information on the cleaning agent.

Carry out manual cleaning and disinfection

- Remove soilings with a wet wipe.

WARNING

Penetrating liquid may cause malfunction of or damage to the device, which may endanger the patient. Only wipe-disinfect items and make sure no liquids penetrate into the device.

- 1 Carry out surface disinfection.
- 2 After contact time, remove disinfectant residues.

Semicritical medical products

Manual cleaning

Manual cleaning should preferably be carried out under running water or with commercially available cleaning agents based on mild alkaline compounds.

Carry out manual cleaning

- 1 Wash off visible soilings under running water. Using an ultrasound cleaner improves cleaning results.
- 2 Use cleaning agents in accordance with manufacturer's specifications. Make sure that all surfaces to be cleaned can be efficiently reached.
 - Place parts bubble-free into the solution for approx. 20 minutes.
 - Agitate all parts thoroughly in the solution at the beginning and at the end of the storage. Brush all parts of the breathing valve.
 - When rinsing hoses, let the solution flow through the entire hose by lifting and lowering it.
 - Rinse the connectors of the flow sensor and the red rubber disc several times with the solution, e.g., by using a syringe.
 - Squeeze the silicone diaphragm several times in the solution.
- 3 Rinse items under running water until cleaning agent residue is no longer discernible.
- 4 Inspect items for visible soiling and a damage. If necessary, repeat manual cleaning.

Manual disinfection

Manual disinfection should preferably be carried out with disinfectants based on aldehydes or quaternary ammonia compounds.

Observe the applicable country-specific listings for disinfectants. The list of the German Association for Applied Hygiene (Verbund für Angewandte Hygiene VAH) applies in German-speaking countries.

The composition of the disinfectant is the responsibility of the manufacturer and can change over time.

Strictly observe the manufacturer's information on the cleaning agent.

Carry out manual disinfection

- 1 Disinfect items by immersing bubble-free for approx. 30 minutes.
- 2 Carry out manual cleaning as described in step 2 of "Carry out manual cleaning" on page 128.
- 3 After contact time, rinse items under running water until disinfectant residue is no longer discernible.
- 4 Inspect items for visible soiling and damage. If necessary, repeat manual disinfection.
- 5 Thoroughly shake out residual water and allow items to dry completely.

Machine cleaning and disinfection

Use washer-disinfector in accordance with EN ISO 15883, preferably with a cart for anesthesia and ventilation accessories, for automatic cleaning and disinfection. Use mildly alkaline or enzymatic (with neutral pH) cleaning agent. Strictly observe the manufacturer's information on the cleaning agent.

Carry out machine cleaning and disinfection

- 1 Strictly observe Instructions for Use of washer-disinfector.
- 2 Position items so that all interior spaces are completely flushed and water can drain off freely.
 - Connect hoses to suitable nozzle of the carriage in the washer-disinfector and place them evenly.
 - Connect breathing valve (without cover and silicone diaphragm) with a short breathing hose (e.g., 35 cm silicone breathing hose, order no. 2165619) to a suitable nozzle of the carriage in the washer-disinfector.
- 3 Use suitable cleaning agent.
- 4 Select suitable program (preferably anesthesia program).
 - Cleaning must be carried out at 40 °C to 60 °C (104 °F to 140 °F) for at least 5 minutes.
 - Thermal disinfection must be carried out at 80 °C to 95 °C (179 °F to 203 °F) and with corresponding contact time.
- 5 Carry out final rinsing with deionized water.
- 6 Immediately remove items from the washer-disinfector.
- 7 Inspect items for visible soiling and damage. If necessary, repeat program or carry out manual cleaning and disinfection.
- 8 Allow items to dry thoroughly.

Visual inspection

Inspect all items for damage and wear, e.g. cracking, embrittlement or pronounced hardening, and residual soiling.

CAUTION

Even accessories designed to be reused have a limited service life. Handling and reprocessing can increase wear and markedly shorten service life (e.g., disinfectant residues can attack the material more intensely during autoclaving). If signs of wear become visible, such as cracks, deformation, discoloration, peeling, etc., affected accessories must be replaced.

Sterilization

Sterilization frees living microorganisms from semi-critical medical products and removes residual water from the interior spaces of its items.

- Only sterilize cleaned and disinfected items.

Use a vacuum steam sterilizer (in accordance with DIN EN 285), preferably with fractional vacuum.

The recommended sterilization temperature and time is 134 °C for 5 minutes.

CAUTION

Do not sterilize parts in ethylene oxide!

Ethylene oxide may diffuse into the parts and cause damage to health.

Reprocessing list

Applicable to non-infectious patients.

The list contains approximate values only. The Instructions for Use of the hospital's infection control officer shall prevail and must be observed by the user!

Components which can be reprocessed	Recommended reprocessing intervals	Machine cleaning and disinfection	Manual		Sterilization
			Cleaning	Disinfection	
Oxylog 3000 <i>plus</i> device and O ₂ hoses	Per patient / if soiled	No	Outside only	Outside only	No
Reusable breathing circuit	Per patient / if soiled	Yes	Possible	Possible	Yes
CO ₂ sensor	Per patient / if soiled	No	Outside only	Outside only	No
Reusable cuvette of the CO ₂ sensor	Per patient / if soiled	Yes	Yes	Yes	Yes
Test filter for CO ₂ sensor	If soiled	No	Yes	Yes	No

Assembling parts

- Reassemble, refer to "Assembly" on page 35 for information.
- Connect to the power supply and gas supply, refer to "Assembly" on page 35 for information.
- Check readiness for operation, refer to "Getting Started" on page 51 for information.

This page intentionally left blank

Maintenance

Maintenance intervals of Oxylog 3000 plus	134
Safety inspections	135
Exchanging the internal battery	136
In case of ventilator failure	136

Maintenance intervals of Oxylog 3000 plus

Definition of Maintenance Concepts

Concept	Definition
Maintenance	Appropriate measures intended to retain the functional condition of a medical device
Inspection	Measures intended to determine and assess the actual state of a medical device
Preventive maintenance	Repeated indicated measures intended to retain the functional condition of a medical device
Repair	Measures intended to restore the functional condition of a medical device after the failure of a device function

Keep a record on all preventive maintenance.

WARNING

In order to avoid malfunctioning of the device, maintenance must be carried out by properly trained service personnel.

WARNING

Clean and disinfect the device or device parts before each maintenance step – and also when returning for repair to minimize risk of infection.

Task	Frequency	Performed by
Replace dust filter ¹⁾	Every two years	Service personnel
Replace internal battery (refer to page 37).	<ul style="list-style-type: none"> – Every two years – When the battery no longer remains charged for the specified operating time²⁾. 	User
Device inspection and maintenance (including safety inspections)	Every two years	Service personnel
CO ₂ sensor inspection and maintenance	Every two years	Service personnel

1) The dust filter can be treated as household waste.

2) Refer to "Technical Data" section for the battery operating time.

Safety inspections

Scope

- 1 Check the accompanying documents:
 - Instructions for Use present.
- 2 Check equipment for completeness when the product is ready for operation according to the Instructions for Use.
- 3 Check the equipment to make sure it is in perfect condition:
 - Labels complete and legible.
 - No damage.
- 4 Check electrical safety:
 - In accordance with IEC 62353.
- 5 Check safety functions:
 - Correct functioning of the pneumatic safety valve: max pressure 90 mbar.
 - Correct functioning of the emergency breathing valve.
 - Correct functioning of the mains supply failure alarm.
 - Monitoring of the supply pressure.
 - Check the high airway pressure alarm.
 - Check the breathing circuit integrity alarm.
 - Check the proper functioning of the power indicators.
- 6 Perform a device check according to the Instructions for Use.

The safety inspections are no substitute for the inspections and maintenance indicated by the manufacturer, including the preventive exchange of wearing parts.

Exchanging the internal battery

Refer to "Internal rechargeable battery" on page 37

In case of ventilator failure

WARNING

Never operate a ventilator if it has suffered physical damage or does not seem to operate properly.

In this case, always use factory trained or authorized personnel to service the device.

Disposal

Disposing of the medical device	138
Disposal instructions	138
Disposal of the medical device and power supplies	138
Disposing of non-rechargeable batteries	138
Disposal of the hose systems and CO2 cuvettes	138

Disposing of the medical device

At the end of its service life:

- Have the medical device appropriately disposed of by the responsible waste disposal company.
- Observe the applicable laws and regulations.

For countries subject to the EU (European) Directive 2002/96/EC

This device is subject to EU Directive 2002/96/EC (WEEE). In order to comply with its registration according to this directive, this device may not be

disposed of at municipal collection points for waste electrical and electronic equipment. Dräger has authorized a company to collect and dispose of this device. To initiate collection or for further information, visit Dräger on the Internet at www.draeger.com. Use the Search function with the keyword "WEEE" to find the relevant information. If access to Dräger's website is not possible, contact the local Dräger organization.

Disposal instructions

Disposal of the medical device and power supplies

When disposing of the medical device:

- Consult the responsible waste disposal company for appropriate disposal.

Observe the applicable laws and regulations.

Observe the applicable laws and regulations for battery disposal.

Disposal of the hose systems and CO₂ cuvettes

Always follow local regulations governing the disposal of hose systems according to established hospital/EMS procedures.

Disposing of non-rechargeable batteries

WARNING

Risk of explosion and of chemical burns.

Improper handling of batteries can result in explosions and chemical burns.

Do not throw batteries into fire. Do not force batteries open.

- Do not recharge batteries.

The medical device battery contains pollutant substances.

Technical Data

Ambient conditions	140
During operation	140
During storage and transportation	140
Settings	141
Performance data	143
Measured values and curve display	144
Airway pressure measurement	144
Flow measurement	144
CO ₂ measurement	144
Frequency measurement	144
Curve display	144
Monitoring	145
Expiratory minute volume MVe	145
Airway pressure Paw	145
Apnoea alarm time Tapn	145
Data communication (option)	145
Operating data	146
Power supply	146
Gas supply	147
Device specifications	149
Materials used	150
Technical Documentation for the Oxylog 3000 plus according to EMC standard IEC 60601-1-2	152
General Information	152
Electromagnetic Emissions	153
Electromagnetic Immunity	153
Recommended separation distances	155

WARNING

Do not use the device outside the specified environmental and supply conditions, as the device may not operate according to its specifications and may become inoperative.

Ambient conditions

During operation

Temperature	-20 to +50 °C
Temperature range for CO ₂ sensor	+10 to +40 °C
CO ₂ sensor	Usage outside this temperature range may decrease sensor accuracy. Usage below +10°C increases the heat up time.
Atmospheric pressure	570 to 1200 hPa
Automatic atmospheric pressure compensation	within operating pressure range
Operating pressure for AC/DC power pack	700 to 1200 hPa
Operating pressure for CO ₂ sensor	570 to 1100 hPa
Relative humidity	5 to 95 % (no condensation)

During storage and transportation

Ventilator without replaceable battery, with reusable hose system

Temperature	-40 to +75 °C
Atmospheric pressure	570 to 1200 hPa
Atmospheric pressure for CO ₂ sensor	115 to 1100 hPa
Relative humidity	5 to 95 % (no condensation)



Disposable adult and paediatric hose systems

Temperature	-20 to +70 °C
Atmospheric pressure	570 to 1200 hPa
Relative humidity	5 to 95 % (no condensation)

Replaceable battery

Temperature	-20 to +35 °C
Atmospheric pressure	570 to 1200 hPa
Relative humidity	5 to 95 % (no condensation)

Settings

Ventilation modes		VC-CMV, VC-AC, VC-SIMV, VC-SIMV/PS, SpnCPAP, SpnCPAP/PS, PC-BIPAP, PC-BIPAP/PS Optional: AutoFlow for VC-CMV, VC-AC and VC-SIMV (/PS)
Respiratory rate RR		2 to 60 /min (VC-SIMV, PC-BIPAP) 5 to 60 /min (VC-CMV, VC-AC) 12 to 60 /min for apnoea ventilation
Ventilation time ratio I:E		1:100 to 50:1
Inspiratory time Ti		0.2 to 10 s
Tidal volume VT		0.05 to 2.0 L, BTPS Measured values referred to the conditions of the patient's lungs, body temperature 37 °C, airway pressure, water-vapor-saturated gas.
	Accuracy of Setting	±15 % of set value or ±25 mL, whichever is greater (adult breathing hose). ±15 % of set value or ±15 mL, whichever is greater (paediatric breathing hose).
Inspiratory pressure P _{insp}		PEEP +3 to +55 mbar
O ₂ concentration		40 to 100 Vol.%
	Accuracy of Setting	±10 Vol.% The actual value depends on the inspiratory flow ¹⁾ and mean airway pressure.
Positive end expiratory pressure PEEP		0 to 20 mbar, no negative pressure.
Trigger sensitivity (flow trigger)		1 to 15 L/min
Pressure Support ΔP_{supp}		0 to 35 mbar (relative to PEEP)
		Rise time for Pressure long (1 s), standard (0.4 s), short. Support
Alarm limit ranges		
	Alarm	Alarm limit range
	MVe 	2 to 41 L/min
	MVe 	0.5 to 40 L/min

Technical Data

RRsp 

10 to 100/min

etCO₂ 

1 to 100 mmHg / 0.1 to 13.3 kPa / 0.1 to 13.3 Vol.%

etCO₂ 

0 to 100 mmHg / 0 to 13.3 kPa / 0 to 13.3 Vol.%

1) see O₂ concentration, page 79

Performance data

Control principle	Time-cycled, volume-constant, pressure-controlled
Maximum inspiratory flow	100 L/min ¹⁾
Device compliance	
with 1.5 m adult breathing hose	≤1 mL/mbar
with 3 m adult breathing hose	≤2 mL/mbar
with 1.9 m paediatric breathing hose	≤0.7 mL/mbar
Device inspiratory and expiratory resistance with adult hose systems	≤6 mbar at 60 L/min ≤4 mbar at 30 L/min ≤2 mbar at 5 L/min
Device inspiratory and expiratory resistance with paediatric disposable hose systems	≤5 mbar at 30 L/min ≤2 mbar at 5 L/min
Dead space including flow sensor, but excluding accessories such as filters, HMEs and CO ₂ cuvettes	approximately 35 mL ²⁾ (reusable adult hose system). approximately 30 mL ²⁾ (disposable adult hose system). approximately 15 mL ²⁾ (disposable paediatric hose system).
Dead space CO ₂ cuvettes	approximately 4 ml (adult CO ₂ cuvette). approximately 1.5 mL (paediatric CO ₂ cuvette).
Resistance CO ₂ cuvettes	<1 mbar at 60 L/min. (adult CO ₂ cuvette). <5 mbar at 30 L/min. (paediatric CO ₂ cuvette).
Supplementary functions	
Demand valve	Opens the breathing system upon failure of the gas supply, permits spontaneous breathing with ambient air.
Relief valve	Opens the breathing system in case of device failure at approximately 80 mbar.
Patient connection	22 mm ISO conical connector

1) At service pressures >350 kPa.

The maximum inspiratory flow is reduced to 80 L/min at service pressures <350 kPa and to 39 L/min at service pressures <280 kPa.

2) When using an accessory with a female connector, add 2 mL to the hose system dead space.

Measured values and curve display

Airway pressure measurement

Range	0 to 100 mbar
Resolution	1 mbar
Accuracy	±2 mbar

Flow measurement

Minute volume MVe

Range	0 to 100 L/min, BTPS
Resolution	0.1 L/min
Accuracy	±15 % of measured value, or ±0.4 L/min, whichever is greater.

Tidal volume VTe

Range	0 to 5000 mL, BTPS
Resolution	1 mL
Accuracy	±15 % of measured value, or ±20 mL, whichever is greater (adult breathing hose). ±15 % of measured value, or ±15 mL, whichever is greater (paediatric breathing hose).

CO₂ measurement

Range	0 to 120 mmHg / 0 to 15.8 Vol.% / 0 to 16.0 kPa
Resolution	1 mmHg / 0.1 Vol.% / 0.1 kPa
Accuracy	0.43 % by volume +8 % of the CO ₂ concentration as per ISO 21647:2004
Total system response time	200 ms

Frequency measurement

Range	0 to 99/min
Resolution	1/min
Accuracy	±1/min

Curve display

Airway pressure Paw (t)	-10 to 100 mbar
Flow (t)	-120 to 120 L/min
CO ₂	-5 to 120 mmHg / -1 to 16 Vol.% / -1 to 16 kPa

Monitoring

Expiratory minute volume MVe

Alarm, upper alarm limit		When the upper alarm limit has been exceeded.
	Range of settings	2 to 41 L/min
Alarm, lower alarm limit		When the level drops below the lower alarm limit.
	Range of settings	0.5 to 40 L/min

Airway pressure Paw

Alarm, upper alarm limit		When value "Pmax" is exceeded.
	Range of settings	20 to 60 mbar
Alarm, lower alarm limit		When the pressure difference between inspiratory and expiratory phases is less than 5 mbar. Or If the set pressure level is not attained.

Apnoea alarm time Tapn

Alarm		When respiratory activity is no longer detected.
	Range of settings	15 to 60 s

Data communication (option)

Exported data		Measured values Curves Alarms Alarms settings User settings Data (trigger) to activate the monitoring of loops For the Data communication protocol contact your local DrägerService.
---------------	--	--

Operating data

Power supply

Power supply

Oxylog 3000 *plus* 24 V ±6 VDC
 Input voltage

Power supplies (AC/DC power pack and DC/DC converter) are specified as part of the Oxylog 3000 *plus*.

Current consumption

With battery charging maximum 2.4 A at 19 VDC
 Typical 2.1 A

Operating time with fully charged internal battery without mains power supply for "typical" ventilation approximately 4 hours

Battery type

Lithium ion battery

Charging time

Approx. 5 hours

The specified charging time applies when recharging the battery completely after it has been depleted. Charging of a completely depleted battery is only possible when the ventilator is switched OFF.

Permissible ambient temperature during charging

0 °C to 35 °C

Indication of battery capacity

in 25 % increments.

Accuracy of the capacity indication

The indicated capacity is determined by the battery itself. The accuracy depends on the type and manufacturer and may deteriorate with frequent partial discharge and during operation in extreme temperatures. The internal battery is only reconditioned after being discharged completely and recharged at room temperature 25 °C. The criteria for the warnings **!!! Int. battery discharged** and **!! Charge int. battery** are therefore based on measurement of the battery voltage. The capacity indicated at this moment may differ from the actual capacity of the internal battery.

	Battery storage time	The internal battery must always be removed from the ventilator for storage and recharged completely after 12 months at the latest (e.g. in the external battery charging station).
AC/DC power pack	Protection class (as defined in IEC 60601-1)	Class II
	IP classification	IP40
	Input	100 to 240 V~ / 50 to 60 Hz / 0.9 to 0.4 A~
	Output	19 V ±0.5 V / 2.6 A (-20 °C to 40 °C) / 1.3 A (40 °C to 50 °C)
	Fuse F1 and F2	T1.25 AH / 250 V~ To isolate the ventilator system from mains, disconnect the power cable from the wall connector. The intended use of the AC/DC power pack is in stationary situations (e.g. in hospitals or fire stations).
DC/DC converter	IP classification	IP42
	Temperature range	-20 °C to +50 °C
	Input	12 / 24 / 28 VDC; 5 A / 2.5 A / 2.1 A
	Output	19 V ±0.5 V / 2.6 A
	Fuse	Type: FP1 MINI Style PCB fuse Voltage: 32 VDC Current: 10 A Breaking capacity: 1000 A, 32 VDC Operating speed: Fast-acting The intended use of the DC/DC converter is in vehicles.
Gas supply		From a pipeline system or from an O ₂ cylinder.
	O ₂ service pressure	270 kPa to 600 kPa at 100 L/min
	Supply gas	Medical oxygen
	O ₂ inlet connection	either: NIST ¹⁾ to EN 739 / ISO5359, or DISS ²⁾ to CGA V5-1989, or N-F ³⁾ S90-116

WARNING

Only use medical grade oxygen.

Gas cylinders and
pressure reducers

WARNING

Only use compressed gas cylinders and pressure reducers, which comply with all applicable regulations and have been approved.

Pressure reducer

Must have a vent valve on the output side to limit the delivery pressure to approximately 1000 kPa in the event of a fault.

Gas consumption for
internal control

Average 0.5 L/min

Accuracy of gas
consumption indication

15 % or ± 1 L/min, whichever is greater.

- 1) NIST = National Institute of Standards and Technology
- 2) DISS = Diameter Index Safety Systems
- 3) N-F = Norme française

Device specifications

Noise pressure of typical ventilation	<45 dB(A) at a distance of 1 m.
Noise pressure of alarm signals	52 to 67 dB(A) at a distance of 1 m.
Dimensions (W x H x D)	
Basic unit	290 x 184 x 175 mm (without handle and protection bracket)
Protection bracket	75 mm (in addition to the width of the basic unit)
AC/DC power supply	167 x 50 x 90 mm
DC/DC converter	160 x 35 x 60 mm
Weight	
Basic unit without internal battery	approximately 5.3 kg
Basic unit with internal battery	approximately 5.8 kg
AC/DC power pack	approximately 0.6 kg
DC/DC converter	approximately 0.6 kg
Electromagnetic compatibility (EMC)	
	Complying with IEC 60601-1-2:2007, EN 794-3 (36.101) 10 V/m, ISO 10651-3 (36.202.2.1) 30 V/m and UN Regulation No. 10, revision 3, with respect to EMC for use in motor vehicles, equivalent to European Commission Directive 2004/104/EC
	RTCA DO-160F with respect to EMC for use in aircraft and helicopters.
Classification according to Directive 93/42/EEC	Class IIb
UMDNS-Code Universal Medical Device Nomenclature System	18 – 098
Protection class, breathing circuits (disposable or reusable), including CO ₂ sensor, endotracheal tubes, or masks	Type BF  (body floating, defibrillation-proof).
Type of protection against ingress of liquids	IPX4
Protection class, CO ₂ sensor	IP64
Defibrillation recovery time	0 s

Display

Technology	Electro-luminescence (EL)
Pixels	240 x 128
Visible area	108 x 56 mm

Materials used

Housing, Oxylog 3000 <i>plus</i>	Acrylonitrile styrene acrylate/polycarbonate (ASA/PC)
Housing, AC/DC power pack	Thermoplastic Copolyester Elastomer (TPC) Acrylonitrile butadiene styrene/polycarbonate (ABS/PC)
Housing, DC/DC converter	Polycarbonate (PC)
Touch sensitive keypad on ventilator	Polyester film

NOTE

All Dräger breathing hoses are latex-free.

Reusable adult hose system

Breathing hose, flow measuring lines	Silicone rubber
Flow sensor housing, breathing valve	Polysulphone (PSU)
Vane in flow sensor	Stainless steel
Diaphragms in breathing valve	Silicone rubber

Disposable adult hose system

Breathing hose	Polyethylene (PE)
Non-return valve	Polypropylene (PP), silicone rubber
Breathing valve	Polypropylene (PP), silicone rubber
Flow sensor housing	Polymethyl methacrylate (PMMA)
Vane in flow sensor	Polyester
Patient connection	Polyethylene (PE), Polypropylene (PP), K-Resin®, Thermoplastic Polyether Elastomer (TPE)

Disposable paediatric hose system

Breathing hose	Ethylene Vinyl Acetate (EVA)
Non-return valve	Housing: Polypropylene (PP) Membrane: silicone rubber

	Breathing valve	Housing: Polypropylene (PP) Membrane: silicone rubber
	Flow sensor housing	Methacrylate-Acrylonitrile Butadiene Styrene (MABS)
	Patient connection	Polycarbonate (PC)
	Y-piece	Polycarbonate (PC)
	Vane in flow sensor	Polyethylene terephthalate (PET)
	Connectors	Polypropylene (PP) and Polycarbonate (PC)
CO ₂ sensor	Housing	Polysulfone
	Cable	Polyurethane
Cuvette	Disposable	K-Resin® SBC
	Reusable	Polysulfone (PSU) with sapphire windows

Technical Documentation for the Oxylog 3000 *plus* according to EMC standard IEC 60601-1-2

General Information

The EMC conformity of the Oxylog 3000 *plus* includes the use of following external cables, transducers and accessories:

- AC/DC power pack
- DC/DC Converter
- All-round Wall Holder
- Equipment holder
- Carrying bag
- Quick Power Connector
- Carrying System
- CO₂ sensor
- CO₂ extension cable
- Data communication cable

Refer to the "List of Accessories" on page 167 for additional information.

WARNING

The use of accessories, transducers and cables other than those specified, with the exception of transducers and cables sold by the manufacturer of the Oxylog 3000 *plus* as replacement parts for internal components, may result in increased emissions or decreased immunity of the Oxylog 3000 *plus*.

WARNING

The Oxylog 3000 *plus* should not be used adjacent to or stacked with other equipment; if adjacent or stacked use is inevitable, the Oxylog 3000 *plus* should be observed to verify normal operation in the configuration in which it will be used.

Electromagnetic Emissions

Electromagnetic Emissions		
The Oxylog 3000 <i>plus</i> is intended for use in the electromagnetic environment specified below. The user of the Oxylog 3000 <i>plus</i> should make sure that it is used in such an environment.		
Emissions	Compliance according to	Electromagnetic environment
RF emissions (CISPR 11) ¹⁾	Group 1	The Oxylog 3000 <i>plus</i> uses RF energy only for its internal function. Therefore, its RF emissions are very low and are not likely to cause any interference in nearby electronic equipment.
RF emissions (CISPR 11)	Class B	The Oxylog 3000 <i>plus</i> is suitable for use in all establishments including domestic establishments and those directly connected to the public low-voltage power supply network that supplies buildings used for domestic purposes.
Harmonic emissions (IEC 61000-3-2)	Class A	
Voltage fluctuations / flicker (IEC 61000-3-3)	Complies	

1) Comité international spécial des perturbations radioélectriques (Special international committee on Radio Interference)

Electromagnetic Immunity

Electromagnetic Immunity			
This Oxylog 3000 <i>plus</i> is intended for use in the electromagnetic environment specified below. The user of the Oxylog 3000 <i>plus</i> should make sure that it is used in such an environment.			
Immunity against	IEC 60601-1-2 test level	Compliance level (of the Oxylog 3000 <i>plus</i>)	Electromagnetic environment
Electrostatic discharge, ESD (IEC 61000-4-2)	Contact discharge: 6 kV Air discharge: 8 kV	8 kV 15 kV	Floors should be wood, concrete or ceramic tile. If floors are covered with synthetic material, the relative humidity should be at least 30 %.
Electrical fast transients / bursts (IEC 61000-4-4)	Power supply lines: 2 kV Longer input/output lines: 1 kV	2 kV 1 kV	Mains voltage quality should be that of a typical commercial or hospital environment.
Surges on AC mains lines (IEC 61000-4-5)	Common mode: 2 kV Differential mode: 1 kV	2 kV 1 kV	Mains voltage quality should be that of a typical commercial or hospital environment.

Immunity against	IEC 60601-1-2 test level	Compliance level (of the Oxylog 3000 <i>plus</i>)	Electromagnetic environment
Power frequency magnetic field 50/60 Hz (IEC 61000-4-8)	3 A/m	3 A/m	Test is not necessary because the Oxylog 3000 <i>plus</i> is not likely to be sensitive to magnetic field disturbances, such as CRT monitors or hall elements.
Voltage dips and short interruptions on AC mains input lines (IEC 61000-4-11)	dip >95 %, 0.5 periods dip 60 %, 5 periods dip 30 %, 25 periods dip >95 %, 5 seconds	>95 %, 0.5 periods 60 %, 5 periods 30 %, 25 periods >95 %, 5 seconds	No voltage dips or short interruptions, since a fully charged battery must be installed for safety reasons, even when operating from an external supply.
Radiated RF (IEC 61000-4-3)	80 MHz to 2.5 GHz: 10 V/m	30 V/m	Recommended separation distance from portable and mobile RF transmitters with transmission power PEIRP to the Oxylog 3000 <i>plus</i> including its lines: 1.84 m * ✓ PEIRP (X1) NOTE The CO ₂ sensor has a lower compliance level (20 V/m) but will fail in a safe way.
RF coupled into lines (IEC 61000-4-6)	150 kHz to 80 MHz: 10 V _{rms} within ISM bands, 3 V _{rms} outside ISM bands (X2)	10 V _{rms} 10 V _{rms}	Recommended separation distance from portable and mobile RF transmitters with transmission power PEIRP to the Oxylog 3000 <i>plus</i> including its lines: 1.84 m * ✓ PEIRP (X1)

Information regarding separation distances (IEC 60601-1-2, tables 5 and 6).

X¹) For PEIRP the highest possible "equivalent isotropic radiated power" of the adjacent RF transmitter has to be inserted (value in Watt). Also in the vicinity of equipment marked with the symbol  interference may occur. Field strengths from fixed, portable or mobile RF transmitters at the location of the Oxylog 3000 *plus* should be less than 3 V/m in the frequency range from 150 kHz to 2.5 GHz and less than 1 V/m above 2.5 GHz.

X²) ISM bands in this frequency range are: 6.765 MHz to 6.795 MHz, 13.553 MHz to 13.567 MHz, 26.957 MHz to 27.283 MHz, 40.66 MHz to 40.70 MHz.

Recommended separation distances

Recommended separation distances between portable and mobile RF telecommunication devices and the Oxylog 3000 *plus*.

The table below gives examples of the most common devices. If a device is not listed, Dräger recommends the following actions:

- 1 Check the product manual of the device for the power (W) and the frequency (GHz) values that the device transmits.
- 2 In the table below, search for the power (W) value of the device in the PEIRP (W) column.
- 3 On the correct table row, search for the distance that corresponds to the frequency of the device.

Recommended separation distances between portable and mobile RF telecommunication devices and the Oxylog 3000 <i>plus</i>			
Maximum PEIRP (W)	Separation distance according to frequency of transmitter (m)		Examples
	150 kHz to 2.5 GHz	< 150 kHz or > 2.5 GHz	
0.001	0.06	0.17	
0.003	0.10	0.30	
0.010	0.18	0.55	e.g. Garage door openers
0.030	0.32	0.95	e.g. WLAN 5250 / 5775 (Europe)*
0.100	0.58	1.7	e.g. WLAN 2440 (Europe), Bluetooth*
0.200	0.82	2.5	e.g. WLAN 5250 (not in Europe)*
0.250	0.91	2.8	e.g. DECT devices*
1.000	1.8	5.5	e.g. GSM 1800- / GSM 1900- / UMTS- mobiles, WLAN 5600 (not in Europe)*
2.000	2.6	7.8	e.g. GSM 900 mobiles*
3.000	3.2	9.5	

Information regarding separation distances (IEC 60601-1-2, tables 5 and 6).

* Telecommunication devices. For the correct type, check the product manual of the device.

This page intentionally left blank

Principles of Operation

Ventilation modes	158
VC-CMV	158
VC-AC	158
VC-SIMV	159
PS	160
PC-BIPAP	161
AutoFlow	162
Start up behavior of AutoFlow	163
Dead space	164
Determining the cycle time, inspiratory time and expiratory time	164
Functional description	165
Gas supply	165
Inspiration	165
Expiration	165
Safety	166
Software	166
Monitoring	166
CO2 measurement	166

Ventilation modes

VC-CMV

Volume Controlled - Controlled Mandatory Ventilation

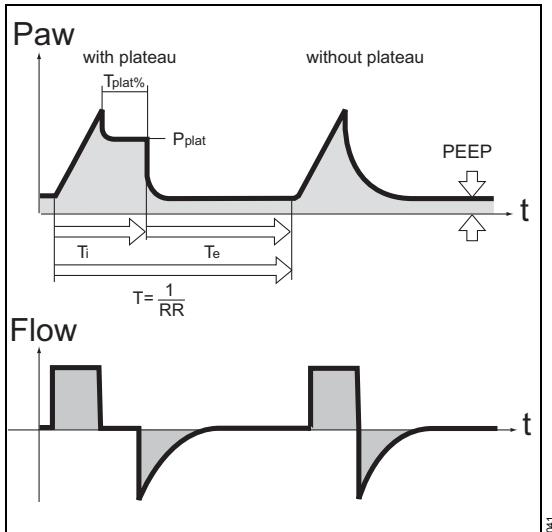

In this mode only mandatory volume controlled strokes are delivered to the patient. The ventilation pattern is specified by the settings for tidal volume **VT**, respiratory rate **RR**, ventilation time ratio **I:E** or inspiratory time **Ti** and **PEEP**.

At the end of the flow delivery phase, the expiratory valve remains closed until the end of the inspiratory time. This phase, the inspiratory pause, can be identified as the plateau **Tplat%** and is defined as a percentage of the inspiratory time.

VC-AC

Volume Controlled - Assist Control

Assisted ventilation with continuous positive airway pressure.

VC-AC provides volume controlled strokes. These strokes can be synchronized with the patient's spontaneous breathing. The mandatory ventilation pattern is specified as VC-CMV, but the mandatory breath begins when the patient reaches an inspiratory flow corresponding to at least to the set flow trigger.

The actual ventilation respiratory rate may be higher than the set respiratory rate.

VC-SIMV

Volume Controlled - Synchronized Intermittent Mandatory Ventilation

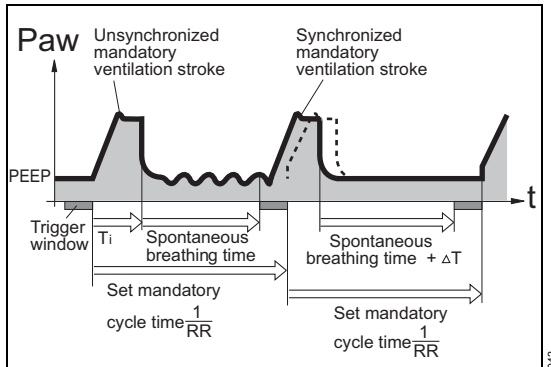

VC-SIMV provides a combination of mandatory ventilation and spontaneous breathing. It enables the patient to breathe spontaneously, with the mechanical mandatory breaths providing minimum ventilation. The minimum ventilation is controlled by the two set values of the tidal volume **VT** and respiratory rate **RR** and is determined from the product of $VT \times RR$.

The mandatory ventilation pattern results from the ventilation parameters of the tidal volume **VT**, respiratory rate **RR**, ventilation time ratio **I:E** or inspiratory time **Ti** and the plateau time **Tplat%**. To prevent the mandatory breath from being applied during spontaneous expiration, the flow trigger of the ventilator ensures that the breath is triggered in synchrony with the patient's spontaneous inspiratory effort within a fixed time window during expiration.

The trigger window has a duration of 5 seconds. If the expiratory time is less than 5 seconds, the trigger window covers the entire expiratory time minus a minimum expiratory time of 500 ms.

Since the synchronization of the mandatory breath reduces the effective spontaneous breathing time, which would result in an undesirable increase in effective respiratory rate, the Oxylog 3000 *plus* prolongs the spontaneous breathing time of the

subsequent breath by the difference ΔT - thus preventing an increase in SIMV frequency. The respiratory rate **RR** remains constant.

The respiratory rate **RR** and tidal volume **VT** set the minimum ventilation, as in VC-CMV and VC-AC.

During the spontaneous breathing phases, the patient can be assisted with pressure by Pressure Support PS.

Generally, in the course of progressively weaning the patient from artificial ventilation, the respiratory rate of the breaths is further reduced. This increases the spontaneous breathing time, so that the required total minute volume **MV** is increasingly supplied by spontaneous breathing.

PS

Pressure Support

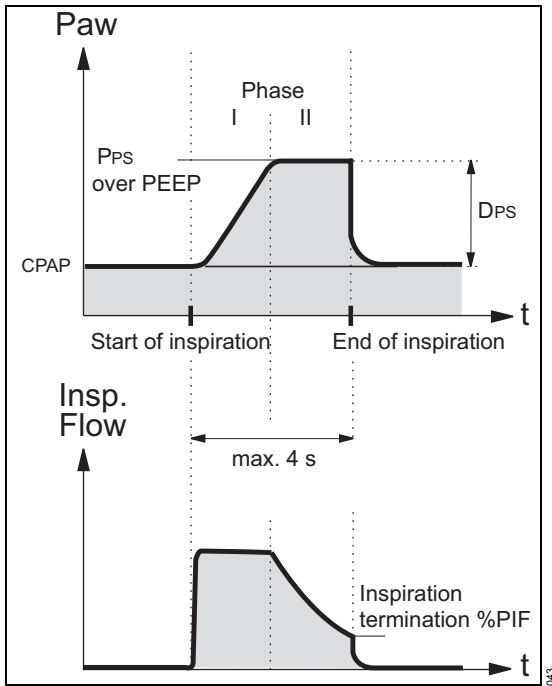

Pressure Support for insufficient spontaneous breathing.

PS can be used in combination with VC-SIMV, PC-BIPAP and Spn-CPAP. With PS the device supports the inhalation. The patient has control of the spontaneous respiratory rate. During PS strokes, the spontaneously breathing patient is supplied with breathing gas, even if the inspiratory effort is weak.

The Pressure Support is started when the spontaneous inspiration flow reaches the set flow trigger level. The device then increases the airway pressure up to the preselected pressure ΔP_{supp} above **PEEP**, which is adjustable to the condition of the patient.

There are three settings for the rate of pressure increase (slope):

- Steep slope: The pressure rise is shorter, i.e. the Oxylog 3000 *plus* supports spontaneous breathing with a faster initial flow rate.
- Flat slope: The pressure rise is longer, i.e. the Oxylog 3000 *plus* supports spontaneous breathing with a slower initial flow rate. In this case, the patient may be required to make greater inspiratory effort.
- Medium slope: It is also possible to choose a setting between a faster or slower initial flow rate.

The slope and the ΔP_{supp} above **PEEP** and the patient's own breathing activity define the inspiration flow.

PS is terminated:

- When after 100 ms the inspiration flow falls below the set inspiration termination criterion as percentage of the peak inspiratory flow (**Inspiration termination %PIF**) (and thus ΔP_{supp} above **PEEP** is reached), or
- After 4 seconds, if the previous criterion has not been fulfilled.

PC-BIPAP

Pressure Controlled - Biphasec Positive Airway Pressure

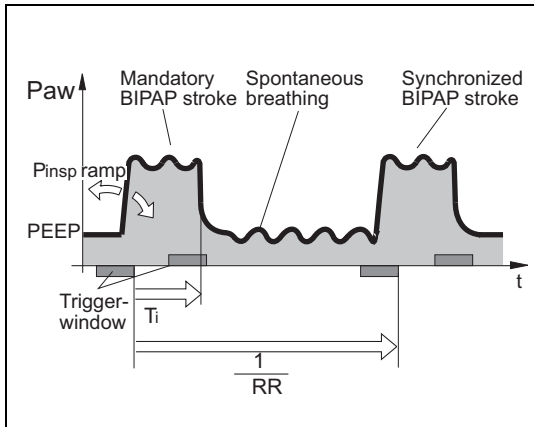

The PC-BIPAP ventilation mode is a pressure controlled / time-cycled ventilation mode, in which the patient can always breathe spontaneously. PC-BIPAP can be described as a time-cycled alternation between two CPAP levels.

The constant option of spontaneous breathing allows the transition from controlled ventilation to independent spontaneous breathing to take place smoothly during the weaning phase, without requiring any change of the ventilation mode. To adapt easily to the patient's spontaneous breathing pattern, the changeover from inspiratory pressure level to expiratory pressure level and visa versa, are synchronized with the patient's spontaneous breathing.

The rate of the changeover is kept constant, even when synchronization occurs via a trigger window. This smooth adaptation to the patient's spontaneous breathing requires less sedation. This means that the patient returns to spontaneous breathing more rapidly.

As in all pressure-controlled ventilation modes, the patient is not prescribed a fixed tidal volume V_T . The tidal volume V_T results principally from the pressure difference between the **PEEP** and **P_{insp}**

and from the lung compliance. An increase in this pressure difference will cause an increased tidal volume V_T .

The measured expiratory tidal volume **V_{Te}** must be used to set the required difference between **PEEP** and **P_{insp}**.

Changes in lung compliance and in the airway, as well as active 'fighting' by the patient can lead to changes in tidal volume V_T . This is a desired effect in this ventilation mode. Because the tidal volume V_T and the resulting minute volume MV are not constant, the alarm limits for minute volume MV_e must be set with care.

Setting PC-BIPAP

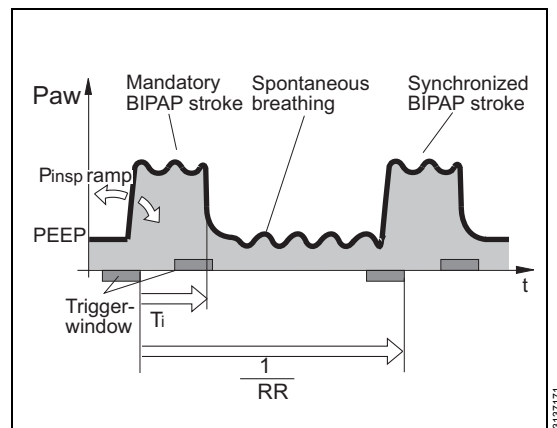

As with VC-SIMV, the time pattern is set using the basic setting parameters of respiratory rate **RR** and ventilation time ratio **I:E** or inspiratory time **T_i**.

The lower pressure level is set with the **PEEP**, while the upper pressure level is set with **P_{insp}**.

When switching over from VC-SIMV to PC-BIPAP, the time pattern remains unchanged, but the **P_{insp}** needs to be set.

The steepness of the increase from the lower pressure level to the upper pressure level is controlled by the **Slope** setting.

During the lower pressure level phase, spontaneous breathing can be assisted by Pressure Support PS. The steepness of the pressure increase to ΔP_{supp} above **PEEP** is also controlled by the **Slope** setting.

Weaning from controlled ventilation to fully spontaneous breathing is achieved by a gradual reduction of inspiratory pressure ***P_{insp}*** and/or the respiratory rate ***RR***.

AutoFlow

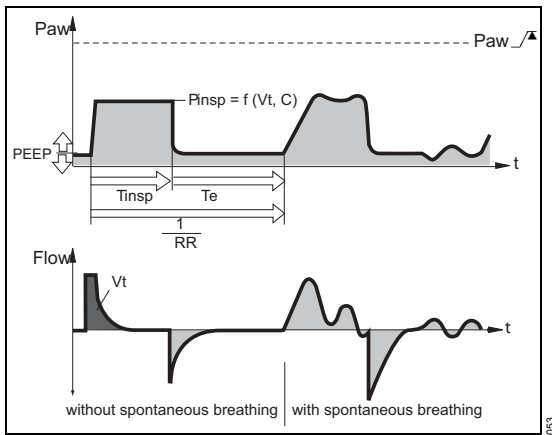

If the set tidal volume ***VT*** cannot be achieved and the maximum inspiratory pressure is reached, the alarm ***VT low, pressure limit*** is generated.

The minimum inspiratory pressure in AutoFlow is limited to:

- 5 mbar above **PEEP** for non-triggered breaths;
- 0.1 mbar above **PEEP** for triggered breaths.

Typically, the selected inspiratory time ***T_i*** is much longer than the lung filling time. The inspiratory pressure ***P_{insp}*** corresponds to the minimum value calculated from the tidal volume and compliance ***C*** of the lungs. The inspiratory flow is automatically controlled, so that there is no pressure peak caused by the resistances of the tube and the airways. With AutoFlow, the inspiratory flow will adjust a maximum of 3 mbar breath to breath.

If the tidal volume ***VT*** is reached (inspiratory flow = 0), before the inspiratory time ***T_i*** has fully elapsed, the Oxylog 3000 *plus* ensures that the patient can breathe during the remaining inspiratory time.

If the patient breathes during mandatory inspiration, the inspiratory pressure remains constant for this breath. Only the inspiratory and the expiratory flow are adapted to the patient's demand. The applied tidal volume may differ from the set tidal volume ***VT*** for spontaneous generated breaths, but on average a constant tidal volume is maintained.

The Oxylog 3000 *plus* terminates an AutoFlow breath if the tidal volume delivered to the patient is 30 % greater than the set tidal volume ***VT***.

AutoFlow (AF) delivers the set tidal volume ***VT*** using a decelerating flow pattern to achieve the lowest peak airway pressure possible. The Oxylog 3000 *plus* determines the pressure required to deliver the set tidal volume ***VT*** based on lung characteristics such as resistance and compliance relationships, and the patient's spontaneous breathing demand.

When the patient inhales, the Oxylog 3000 *plus* delivers additional inspiratory flow.

The maximum inspiratory pressure in AutoFlow is limited to:

- 5 mbar below ***P_{max}***.

The patient's current condition must be considered when setting ***P_{max}***, to avoid the possibility of causing harm if the airway pressure increases. Always set ***P_{max}*** carefully in order to limit the airway pressure in case of a reduced compliance.

Set the alarm limits **MVe high** and **MVe low** appropriately, to be advised in the event of excessive or insufficient flow delivery indicating potential changes in lung characteristics.

During AutoFlow the flow curve in the curve window supplies additional information: If the set inspiratory time **Ti** is shorter than the lung filling time the flow curve will display that inspiratory flow has not returned to baseline at the end of the inspiratory phase. In this case evaluate the condition of the patient to determine the cause of the extended inspiratory time **Ti** in order to further reduce the peak pressure. This effect can also be due to a build-up of secretions. In this situation, the inspiratory pressure is limited by the Oxylog 3000 *plus* as described above. If, as a result, the set tidal volume **VT** can no longer be completely delivered, the alarm **VT low, pressure limit** is generated.

The inspiratory flow rise from the **PEEP** level to the inspiratory level can be even more closely adapted to the needs of the patient by means of the pressure rise time **Slope**.

Start up behavior of AutoFlow

When activating the AutoFlow function, the Oxylog 3000 *plus* delivers a volume-controlled breath using a constant inspiratory flow rate for the duration of the inspiratory time **Ti**. The peak airway pressure generated from this breath will determine the inspiratory pressure for the AutoFlow function.

If no suitable pressure can be determined for this breath or the volume cannot be applied, the following occurs:

- A pressure controlled breath is applied with an inspiratory pressure of 5 mbar above the set **PEEP**. The applied volume is measured and determines an initial target pressure to achieve the set tidal volume **VT**.
- The next breath is applied using an inspiratory pressure that corresponds to 75 % of this target tidal volume pressure. The Oxylog 3000 *plus* measures the applied volume again and determines the subsequent target pressure to reach the set volume.
- The next breath is applied with this target pressure.

The inspiratory pressure of the subsequent breaths is adjusted until the set tidal volume **VT** is reached.

In case of disconnect alarm, this start up behavior is repeated.

Dead space

Dead space is an important aspect of ventilation management:

Dead space is the portion of the respiratory system in which no significant gas exchange occurs. An increase in the proportion of dead space to alveolar ventilation may lead to increased CO₂ retention of carbon dioxide by the patient.

Dead space is present as a component of the patient's artificial airway and hose system. If the volume of the mechanical dead space equals or exceeds the volume of alveolar ventilation, the patient may not be able to adequately eliminate carbon dioxide, therefore it is important to properly manage the volume of dead space in the breathing circuit of the Oxylog 3000 *plus*.

Determining the cycle time, inspiratory time and expiratory time

The basis for determining the Cycle time (total time for a respiratory cycle) during mandatory breaths is the set Respiratory Rate (**RR**). This is complemented with the set inspiratory time (**T_i**) or the set ventilation time ratio (**I:E**).

In case of conflicting settings, the alarms **!! Check settings time** or **!! Check settings flow** are issued to notify the operator to change the settings.

NOTE

The ventilator can be configured to set **T_i** or **I:E**, refer to "Customer Service Mode" on page 98.

However, in case of conflicting settings the ventilator will determine the delivered Cycle time, T_i and T_e in the following order:

- If the set **T_i** is too short for the ventilator to deliver the set tidal volume **V_T**, the delivered T_i is automatically increased. If the resulting T_i exceeds the Cycle time, the Cycle time is automatically increased. Note: This is only applicable in ventilation modes that target a set **V_T**.
- If the set **T_i** exceeds the Cycle time, the delivered T_i is automatically made identical to the Cycle time.
- The T_e always has an absolute minimum time of 0.5 s. If T_e would not fit anymore within the Cycle time (due to a high T_i), the Cycle time is automatically increased.

These rules are also applicable when the ventilator is configured to set **I:E** instead of **T_i**.

Functional description

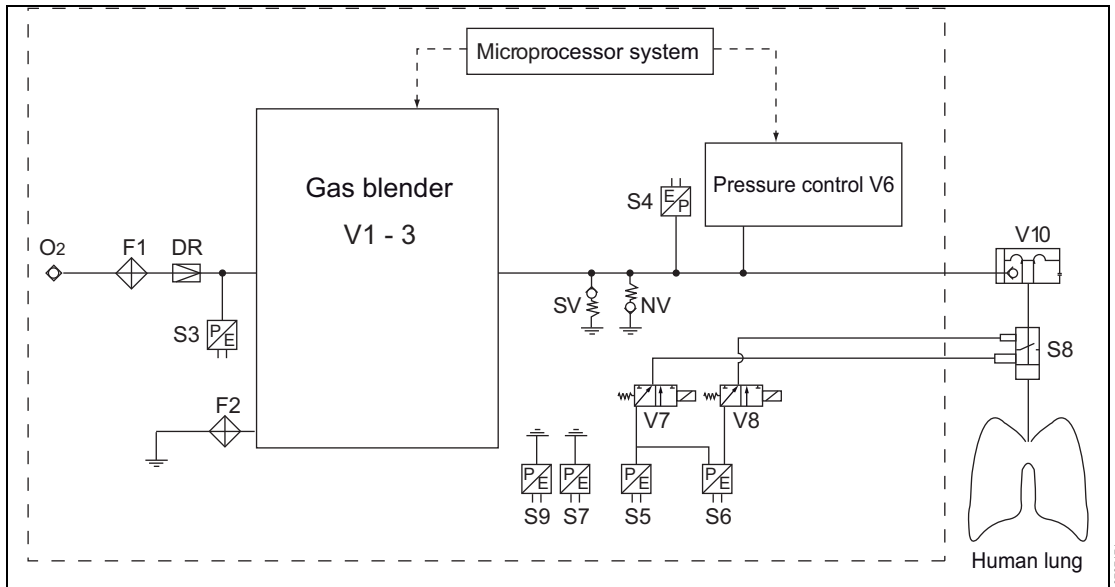

The various pneumatic actuators in the Oxylog 3000 *plus* are controlled by the microprocessor system via digitized electrical signals.

for BTPS, taking into account the ambient pressure. In this way, Oxylog 3000 *plus* meters and measures roughly 10 % less volume in operation with a test lung (dry gas at room temperature).

Gas supply

The supply gas O₂ is purified by filter F1 and adjusted to a constant pressure by pressure regulator DR. Ambient air is taken in via filter F2 as required. The supply pressure is monitored by pressure sensor S3.

Inspiration

Gas blender V1-3 delivers the variable inspiration flow as a mixture of supply gas O₂ and ambient air in accordance with the ventilation mode and required O₂ concentration. The tidal volume is applied regardless of ambient pressure (absolute pressure sensors S7 and S9) under patient conditions BTPS for volume-controlled breathing; the applied tidal volume corresponds with that set

Expiration

During volume-controlled inspiration, Pressure Control V6 closes the inspiratory canal and controls the PEEP pressure during expiration or reduces the pressure in the inspiratory hose to control the PS, P_{insp} or P_{max} pressure when the target values are reached. Breathing valve V10 on the patient side, which is indirectly controlled by V6, seals off against atmospheric air during inspiration and adjusts the required patient pressure during expiration by controlling the pressure in the inspiratory hose. The measured value of the airway pressure sensor S5 on the patient side serves as a set point for pressure regulation.

Safety

In the event of a fault, gas blender V1-3 closes and Pressure Control V6 opens to the atmosphere. The pneumatic demand valve NV (spontaneous breathing) opens in the presence of negative pressure. The pneumatic relief valve SV (set to approximately 80 mbar) opens in the presence of excess pressure.

Software

The software is developed according to the internal software development process and will be subjected to code inspections, integration tests and system tests.

When an error has been detected the device will fail in a fail safe mode.

Monitoring

The flow measured on the patient side by S8 is transmitted to the internal electronic pressure difference sensor S6 as a differential pressure signal. The measured monitoring values of the tidal volume, minute volume and respiratory rate are derived from the measured expiratory flow. The inspiratory flow signal is used for detection of the flow trigger. System leakages can be identified from the balance of inspiratory and expiratory tidal volumes (e.g. leakage alarm, NIV).

Airway pressure measurement on the patient side supplies the Paw values for the airway pressure on the display via S5, as well as for the derived measured values PEEP, PIP, Pplat, Pmean. The plausibility of this airway pressure measurement on the patient side is monitored by a redundant internal airway pressure measurement in the ventilator via S4 in the inspiratory duct.

CO₂ measurement

CO₂ is measured via a mainstream system based on absorption measurement. A light source generates a spectrum and two light detectors record the characteristic absorption spectrum and supply electrical signals that change with the CO₂ concentration. These signals are then evaluated and displayed. Heating the CO₂ sensor probe prevents condensation.

When the CO₂ sensor is connected or had a power supply failure, it will first complete its warm-up phase (approximately 3 minutes). During warm-up:

- etCO₂ and CO₂ values may have a reduced accuracy;
- Zero calibration and filter check remain on hold;
- The alarm **!!! Check cuvette type** is inactive.

List of Accessories

Part name	Part no.
Workstation	
Oxylog 3000 <i>plus</i>	57 04 833
Basic unit	
Oxylog 3000 <i>plus</i>	57 04 811
Accessories required for operation	
Power supply:	
AC/DC power pack 100-240 V/50-60 Hz	57 04 750
Available power cables:	
– Germany and Europe	18 24 481
– Denmark	18 68 950
– United Kingdom	18 44 369
– Australia	18 51 705
– Switzerland	18 44 377
– USA	18 41 793
– China	18 59 706
– Brazil	18 75 523
– Thailand	18 68 160
Isolated DC/DC converter	57 04 799
Lithium ion battery	2M 86 733

Part name	Part no.
Adult reusable breathing hose set, comprising:	
– Breathing hose with measuring leads, 1.5 m	84 12 068
– Breathing hose with measuring leads, 3 m	84 12 913
– Breathing valve	84 12 001
– Flow sensor	84 12 034
– Angled connector	84 12 235
Ventstar Oxylog Adult disposable breathing circuit kit 1.5 m (set of 5)	57 03 041
Ventstar Oxylog Adult disposable breathing circuit kit 3.0 m (set of 5)	MP 00 335
Ventstar Oxylog Paediatric breathing system kit 1.9 m (disposable, set of 5)	57 04 964
Connecting hoses	
Gas Supply System	57 04 500
Special accessories	
Equipment Holder	2M 86 900
Battery Charger	2M 86 729
All-round Wall holder	57 04 216
Carrying System	2M 86 975
Test lung	84 03 201
Data communication cable 0.8 m	57 05 301

Part name	Part no.
Options	
CO ₂ measurement	57 05 331
Real time data export	57 05 332
AutoFlow	57 05 333
O ₂ inhalation	57 05 329
100 % O ₂	57 05 330
CO₂ measurement	
CO ₂ sensor (revision index 04 and higher)	68 71 950
Extension cable for CO ₂ sensor, 90 cm	68 72 159
Reusable CO ₂ Cuvette (adult)	68 70 279
Reusable CO ₂ Cuvette (paediatric)	68 70 280
Disposable CO ₂ Cuvette (adult)	MP 01 062
Disposable CO ₂ Cuvette (paediatric)	MP 01 063
Calibration set CO ₂	8412710
Spare CO ₂ cylinder 5 % for calibration set	6850435

Index

A

Abbreviations	23
AC/DC power pack	40
Accessories	167
Adult hose system, disposable	20, 21
Adult hose system, reusable	20
Airway pressure Paw	145
Alarm - Cause - Remedy	112
Alarms	112
Alarm limits, setting	87
Alarm reset	31
Alarm tones, suppress	85
Alarms window	33
Alarms window, messages	112
In the event of	85
Types of	84
Volume level	81
Ambient conditions	140
Apnoea	
Apnoea alarm, time for	74
Apnoea ventilation	74
AutoFlow	67, 70, 162

B

Bacterial filter	47
Battery	
Capacity indicator	37
Charging	52
Installing	37
Internal	37
Breathing valve	
Assembly	43
Disassembly	125
BTPS	23, 54, 141

C

Calibration	81
Cardio-pulmonary Resuscitation (CPR)	67, 75
Caution	3, 11
Checking readiness for operation	54
Cleaning	123
CO ₂ curves	34
CO ₂ cuvette	
Connecting	48
Disassembling	124
CO ₂ measurement	91, 105

Calibration	107
Description	166
Filter check	93, 106
Gas check	107
Resetting calibration to factory values	108
Zero calibration	92, 105
CO ₂ sensor	
Connecting	48
Disassembling	124
Configuration	95
Connecting the gas supply	41
Contraindications	14
Customer service manual	110
Customer Service Mode	98

D

DC/DC converter	39
Dead space	164
Device check, performing	54
Device specifications	149
Disinfection	123
Display operating controls	30
Disposable hose system	
An overview of	20
Connecting the adult hose system	45
Connecting the paediatric hose system	46
Removing the adult hose system	126
Removing the paediatric hose system	126
Disposal	137

E

Electromagnetic Emissions	153
Electromagnetic Immunity	153
EMC	11, 152
Environment of use	15
Error messages during the device check	122
etCO ₂	90

F

FiO ₂	90
Flow curves	34
Front panel	18
Functional description	165

G

Gas failure	86
Gas supply	41, 147

H

HME filter	
Connecting	47
Setting HME correction	80

I

Information window, messages	120
Insp. hold	77
Intended use	13, 14

L

Language, setting	97
Latex	25, 150

M

Maintenance intervals	134
Manufacturer's default settings	100
Materials used	150
Measured value display	144
Measured values display	
Setting values	102
Monitoring	89
MVe	90
MVspn	90

N

NIV	76
-----------	----

O

O ₂	29
O ₂ blending 40 % to 100%	79
O ₂ concentration with O ₂ blending	79
O ₂ cylinder	41
O ₂ -Inhalat.	31
Operating concept	28
Operating data	146
Operating time	53
Operating time, pneumatic	53

P

Paediatric hose system, disposable	46
Patient	9
PC-BIPAP, PC-BIPAP/PS	29, 71, 161
PEEP	90
Performance data	143
PIP	90
Pmax	29
Pmean	90
Power failure	86
Power save mode	81
Power supply	37, 146
Pplat	90
Pressure curves main page	34
Pressure limitation	87
Pressure support	69, 72, 160
PS	160

R

Rear view	19
Recommended separation distances	155
Reprocessing list	131
Reprocessing procedure	127
Restrictions of use	15
Resuscitation	
Cardio-pulmonary Resuscitation (CPR)	67, 75
Reusable hose system	
An overview of	20
Assembling	43
Disassembling	124
RR	90
RRspn	90

S

Safety	7
Safety inspections	135
Screen	32
Screen brightness	81
Window structure	32
Separation distances	155
Settings	141
Settings window	33
Shutdown	82
Side view, right	19
Slope	67, 69, 70, 72, 75
SpnCPAP, SpnCPAP/PS	29, 73
Standard rail systems	49
Startup settings	100
Sterilization	123
Switching OFF the device	28, 82

Switching ON the device	28, 55, 62
Symbols	24
System check	56
System overview	17

T

Technical Data	139
Tidal volume	65, 68
Trigger	65, 67, 68, 71, 75, 100, 141

V

Values window	32
VC-AC	29, 65, 158
VC-CMV, VC-AC	29, 65, 158
VC-SIMV	159
VC-SIMV, VC-SIMV/PS	29, 68
Ventilation controls	29
Ventilation modes	22
Description	158
Selecting	29
VT	29
VTe	90

W

Warning	3, 85, 88
---------------	-----------

These Instructions for Use only apply to
Oxylog 3000 plus SW 1.n
with the Serial No.:

If no Serial No. has been filled in by Dräger,
these Instructions for Use are provided for gen-
eral information only and are not intended for
use with any specific machine or device.

This document is provided for customer informa-
tion only, and will not be updated or exchanged
without customer request.



Directive 93/42/EEC
concerning Medical Device

 Manufacturer

Dräger Medical GmbH

 Moisinger Allee 53–55
D-23542 Lübeck
Germany

 +49 451 8 82- 0

FAX +49 451 8 82- 20 80

 <http://www.draeger.com>

57 05 305 – 5503.420 en

© Dräger Medical GmbH

Edition: 6 – 2012-05

(Edition: 1 – 2009-05)

Dräger reserves the right to make modifications
to the equipment without prior notice.

